

Planar Circle Geometries

an Introduction to Moebius–, Laguerre– and
Minkowski–planes

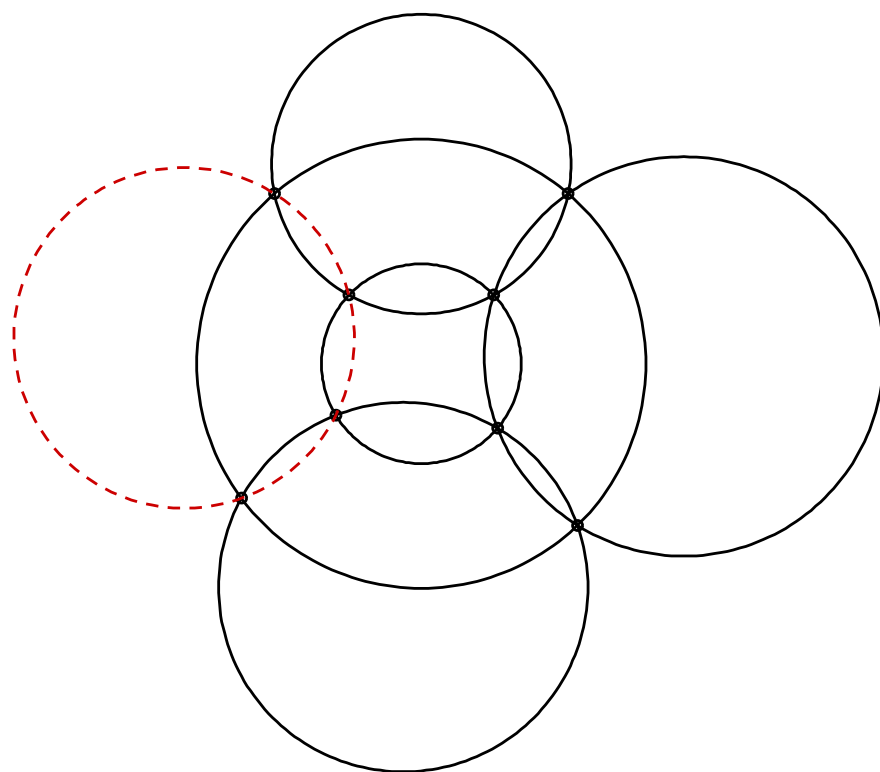

Erich Hartmann

Department of Mathematics
Darmstadt University of Technology

Contents

0	INTRODUCTION	7
1	RESULTS ON AFFINE AND PROJECTIVE GEOMETRY	11
1.1	Affine planes	11
1.1.1	The axioms of an affine plane	11
1.1.2	Collineations of an affine plane	12
1.1.3	Desarguesian affine planes	13
1.1.4	Pappian affine planes	14
1.2	Projective planes	15
1.2.1	The axioms of a projective plane	15
1.2.2	Collineations of a projective plane	15
1.2.3	Desarguesian projective planes	16
1.2.4	Homogeneous coordinates of a desarguesian plane	17
1.2.5	Collineations of a desarguesian projective plane	17
1.2.6	Pappian projective planes	17
1.2.7	The groups $PGL(2, K)$, $PGL(2, K)$ and $PSL(2, K)$	18
1.2.8	Basic 1–dimensional projective configurations	19
2	OVALS AND CONICS	23
2.1	Oval, parabolic and hyperbolic curve	23
2.2	The ovals \mathfrak{c}_1 and \mathfrak{c}_2	24
2.3	Properties of the ovals \mathfrak{c}_1 and \mathfrak{c}_2	26
2.4	Oval conics and their properties	27
2.5	Oval conics in affine planes	39
2.6	Finite ovals	40
2.7	Further examples of ovals	43
2.7.1	Translation–ovals	43
2.7.2	Moufang–ovals	44
2.7.3	Ovals in Moulton–planes	45
2.7.4	Ovals in planes over nearfields	45
2.7.5	Ovals in finite planes over quasifields	45
2.7.6	Real ovals on convex functions	46

3	MOEBIUS–PLANES	47
3.1	The classical real Moebius–plane	47
3.2	The axioms of a Moebius–plane	48
3.3	Miquelian Moebius–planes	50
3.3.1	The incidence structure $\mathfrak{M}(K, q)$	50
3.3.2	Representation of $\mathfrak{M}(K, q)$ over E	51
3.3.3	Automorphisms of $\mathfrak{M}(K, q)$, $\mathfrak{M}(K, q)$ is Moebius–plane	52
3.3.4	Cycle reflections	53
3.3.5	Angles in affine plane $\mathfrak{A}(K, q)$	55
3.3.6	Theorem of MIQUEL in $\mathfrak{M}(K, q)$	56
3.3.7	The sphere–model of a miquelian Moebius–plane	59
3.3.8	Isomorphic miquelian Moebius–planes	60
3.4	Ovoidal Moebius–planes	61
3.4.1	Plane model of an ovoidal Moebius–plane	63
3.4.2	Examples of ovoidal Moebius–planes	64
3.5	Non ovoidal Moebius–planes	64
3.6	Final remark	65
4	LAGUERRE–PLANES	67
4.1	The classical real Laguerre–plane	67
4.2	The axioms of a Laguerre–plane	68
4.3	Miquelian Laguerre–planes	70
4.3.1	The incidence structure $\mathfrak{L}(K)$	70
4.3.2	Automorphisms of $\mathfrak{L}(K)$, $\mathfrak{L}(K)$ is a Laguerre–plane	70
4.3.3	Parabolic measure for angles in $\mathfrak{A}(K)$	72
4.3.4	Theorem of MIQUEL in $\mathfrak{L}(K)$	72
4.4	Ovoidal Laguerre–planes	74
4.4.1	Definition of an ovoidal Laguerre–plane	74
4.4.2	The plane model of an ovoidal Laguerre–plane	75
4.4.3	Examples of ovoidal Laguerre–planes	77
4.4.4	Automorphisms of an ovoidal Laguerre–plane $\mathfrak{L}(K, f)$	77
4.4.5	The bundle theorem for Laguerre–planes	78
4.5	Non ovoidal Laguerre–planes	79
4.6	Automorphisms of Laguerre–planes	80
4.6.1	Transitivity properties of ovoidal Laguerre–planes	83
5	MINKOWSKI–PLANES	87
5.1	The classical real Minkowski–plane	87
5.2	The axioms of a Minkowski–plane	88
5.3	Miquelian Minkowski–planes	91
5.3.1	The incidence structure $\mathfrak{M}(K)$	91
5.3.2	Automorphisms of $\mathfrak{M}(K)$. $\mathfrak{M}(K)$ is a Minkowski–plane	92
5.3.3	Hyperbolic measure for angles in $\mathfrak{M}(K)$	93

5.3.4	Theorem of MIQUEL in $\mathfrak{M}(K)$	93
5.3.5	Cycle reflections and the Theorem of Miquel	95
5.3.6	The hyperboloid model of a miquelian Minkowski-plane	97
5.3.7	The bundle theorem for Minkowski-planes	98
5.4	Minkowski-planes over TITS-nearfields	98
5.4.1	The incidence structure $\mathfrak{M}(K, f)$	98
5.4.2	Automorphisms of $\mathfrak{M}(K, f)$. $\mathfrak{M}(K, f)$ is a Minkowski-plane	99
5.5	Minkowski-planes and sets of permutations	100
5.5.1	Description of a Minkowski-plane by permutation sets	100
5.5.2	Minkowski-planes over permutation groups	101
5.5.3	Symmetry at a cycle. The rectangle axiom	103
5.5.4	The symmetry axiom	106
5.5.5	Minkowski-planes of even order	110
5.6	Further Examples of Minkowski-planes	111
5.6.1	A method for the generation of finite Minkowski-planes	111
5.6.2	Finite examples which do not fulfill (G)	112
5.6.3	Real examples, which do not fulfill (G)	113
5.7	Automorphisms of Minkowski-planes	114
6	Appendix: Quadrics	117
6.1	Quadratic forms	117
6.2	Definition and properties of a quadric	118
6.3	Quadratic sets	121
6.4	Final remarks	123
7	Appendix: Nearfields	125
7.1	Definition of a nearfield and some rules	125
7.2	Examples of nearfields	126
7.3	Planar nearfields	126
7.4	Nearfields and sharply 2-transitive permutationgroups	126
7.5	TITS-nearfields	127

Chapter 0

INTRODUCTION

Because of the parallel relation on the set of lines an *affine plane* is not a homogeneous geometric structure (some lines intersect, others not). This inhomogeneity can be omitted by extending the affine plane to its *projective completion* (Within a projective plane any pair of lines intersect). For *desarguesian* planes the formal inhomogeneity of the projective completion can be abolished by using the 3d-model (1-dim subspaces are points, 2-dim are lines).

Now we start from the real euclidean plane and merge the set of lines together with the set of circles to a set of blocks. This construction results in a rather inhomogeneous incidence structure: two points determine one line and a whole pencil of circles. The trick embedding this incidence structure into a homogeneous one is based on the following idea: Add to the point set the new point ∞ , which must lie on every line. Now any block is determined by exactly 3 points. This new homogeneous geometry is called classical **inversive geometry** or **Moebius-plane**.

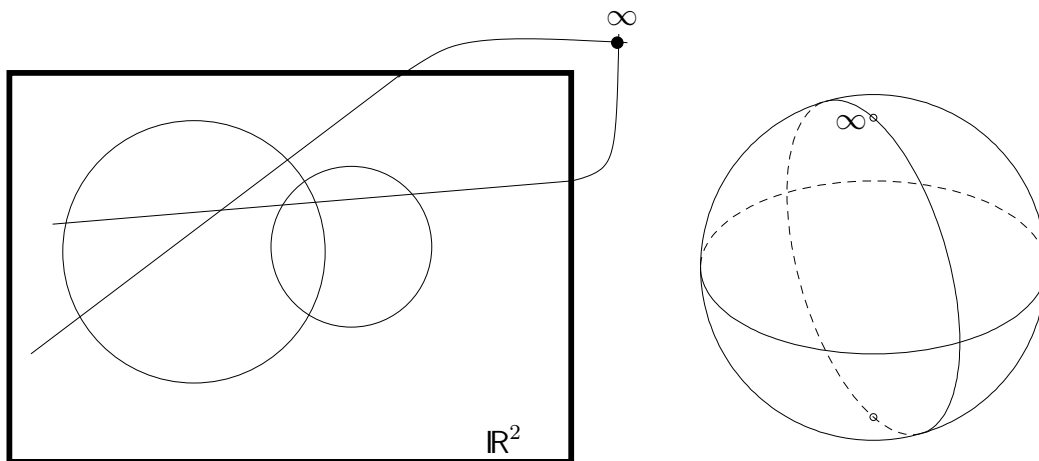

Figure 1: 2d- and 3d-model of a Moebius-plane

The still existing inhomogeneity of the description (lines, circles, new point) can be abol-

ished by using a 3d-model. From a stereographic projection we learn: the classical Moebius-plane is isomorphic to the geometry of plane sections (circles) on a sphere in euclidean 3-space.

Analogously to the (axiomatic) projective plane one calls an incidence structure, which exhibits essentially the same incidence properties, an (axiomatic) **Moebius-plane** (see Chapter 3). Expectedly there are a lot of Moebius-planes which are different from the classical one.

If we start again from \mathbb{R}^2 and take the curves with equations $y = ax^2 + bx + c$ (parabolas and lines) as blocks, the following homogenization is effective: Add to the curve $y = ax^2 + bx + c$ the new point (∞, a) . Hence the set of points is $(\mathbb{R} \cup \infty) \times \mathbb{R}$. This geometry of parabolas is called **classical Laguerre-plane**. (Originally it was designed as the geometry of the oriented lines and circles, see [BE'73]. Both geometries are isomorphic.)

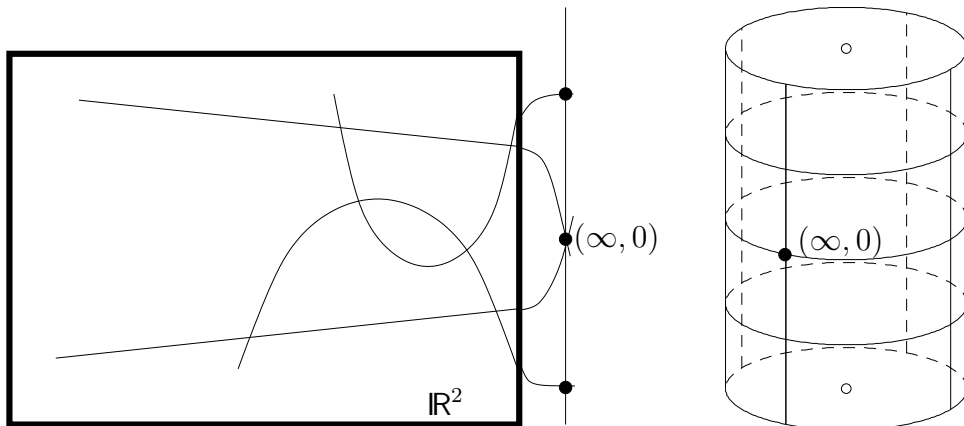

Figure 2: 2d- and 3d-model of a Laguerre-plane

As for the Moebius-plane there exists a 3d-model: the geometry of the elliptic plane sections on an orthogonal cylinder (in \mathbb{R}^3), see Chapter 4. An abstraction leads (analogously to the Moebius-plane) to the axiomatic **Laguerre-plane**.

At least, if we start from \mathbb{R}^2 and merge the lines $y = mx + d, m \neq 0$ with the hyperbolas $y = \frac{a}{x-b} + c, a \neq 0$ in order to get the set of blocks the following idea homogenizes the incidence structure: Add to any line the point (∞, ∞) and to any hyperbola $y = \frac{a}{x-b} + c, a \neq 0$ the two points $(b, \infty), (\infty, c)$. Hence the point set is $(\mathbb{R} \cup \infty)^2$. This geometry of the hyperbolas is called the **classical Minkowski-plane**.

Analogously to the classical Moebius- and Laguerre-planes there exists a 3d-model: The classical Minkowski-plane is isomorphic to the geometry of plane sections of a hy-

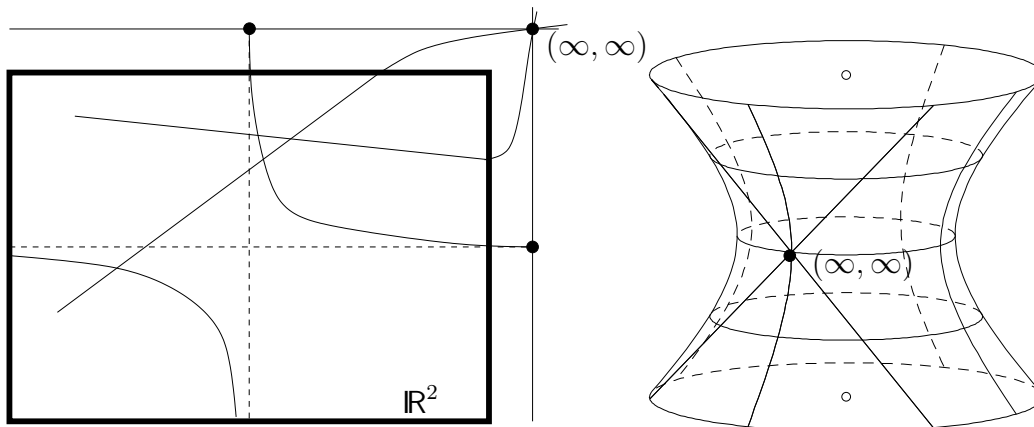

Figure 3: 2d- and 3d-model of a Minkowski-plane

perboloid of one sheet (non degenerated quadric of index 2) in 3-dimensional projective space (see Chapter 5). Similar to the first two cases we get the (axiomatic) **Minkowski-plane**.

Because of the essential role of the circle (considered as *the* non degenerate conic in a projective plane) and the plane description of the original models the three types of geometries are subsumed to **plane circle geometries**.

The prominent classes of the plane circle geometries are built on (commutative) fields with the aid of conics. Therefore a chapter on *oval conics* (Section 2.4) is included into this lecture notes. In order to give support for the understanding of the 3d-models there is added an appendix on *quadrics* (Chapter 6). The appendix on *nearfields* (7) is necessary for the understanding of a wide class of Minkowski-planes.

The lecture notes on hand arose from lectures held at the Department of Mathematics of Darmstadt University of Technology. Because the author's field of interest changed during the past years this lecture notes is not a report on cutting edge results. Its intention is to introduce interesting readers into the subject of circle geometries.

Darmstadt, Oktober 2004

Chapter 1

RESULTS ON AFFINE AND PROJECTIVE GEOMETRY

Literature: [BR'76], [DE'68], [DE,PR'76], [HU,PI'73], [LE'65], [LI'78], [PI'55]

1.1 Affine planes

1.1.1 The axioms of an affine plane

Let be $\mathcal{P} \neq \emptyset$ a set, the set of *points*, and $\mathcal{G} \neq \emptyset$ a subset of the power set of \mathcal{P} , the set of *lines*. A point is called *incident* with a line g , if $P \in g$. Two lines g, h are called *parallel* (designation: $g \parallel h$) if $g = h$ or $g \cap h = \emptyset$.

The incidence structure $\mathfrak{A} := (\mathcal{P}, \mathcal{G}, \in)$ is called **affine plane** if the following axioms hold:

- A1:** For any pair of points P, Q there exists one and only one line g with $P, Q \in g$.
- A2:** For any line g and any point P there exists one and only one line g' with $P \in g'$ and $g \parallel g'$.
- A3:** There are three points not on a common line.

Three points P, Q, R are called *collinear* if there is a line g with $P, Q, R \in g$.

In case of $\|\mathcal{P}\| < \infty$ and $n := \|g\|$ the cardinality of a line then for any line h we have $\|h\| = n$. n is called *order* of the finite affine plane $(\mathcal{P}, \mathcal{G}, \in)$. Further results are: $\|\mathcal{P}\| = n^2$ and $\|\mathcal{G}\| = n^2 + n$.

The **minimal model** of an affine plane has order 2. It consist of 4 points and 6 lines (figure 1.1):

$$\mathcal{P} = \{A, B, C, D\},$$

$$\mathcal{G} = \{\{A, B\}, \{A, C\}, \{A, D\}, \{B, C\}, \{B, D\}, \{C, D\}\}$$

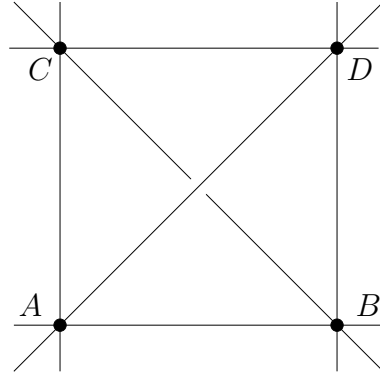

Figure 1.1: Minimal model of an affine plane

1.1.2 Collineations of an affine plane

Let be $\mathfrak{A} := (\mathcal{P}, \mathcal{G}, \in)$ an affine plane and ψ a bijective map of \mathcal{P} onto itself which induces a permutation of the lines. Then ψ is called a *collineation* of \mathfrak{A} . The set of collineations of \mathfrak{A} establishes the group $Koll\mathfrak{A}$.

A collineation $\tau \in Koll\mathfrak{A}$ is called a *translation* if for any line we have $\tau(g) \parallel g$ and if no point or all points are fixed. The fixed lines of a translation $\tau \neq id$ (identity) form a pencil of parallel lines (set of lines parallel to a fixed line). If g is a fixed line of a translation τ then τ is called *translation in direction g* . The set of translations of \mathfrak{A} establishes the *translation group*, analogously the translations in direction g lead to the subgroup $T(g)$ of *translations in g -direction*. For two points A, B there is at most one translation τ with $\tau(A) = B$. A group $T(g)$ is *linear transitive* if for any pair A, B of points on a line parallel to g there exists a translation $\tau \in T(g)$ such that $\tau(A) = B$.

A collineation δ of an affine plane \mathfrak{A} is called *central dilatation* if $\delta(g) \parallel g$ for any line g and if δ has at least one fixpoint. A central dilatation $\delta \neq id$ has exactly one fixed point Z , the center. The set of fixed lines consists of the lines through Z . The set $\Delta(Z)$ of central dilatations with the same fixed point Z is a group. For two points $A, B \in \mathcal{P} \setminus Z$ collinear with Z there is at least one central dilatation $\delta \in \Delta(Z)$ with $\delta(A) = B$. If there exists for any pair of points $A, B \in \mathcal{P} \setminus Z$ collinear with center Z a $\delta \in \Delta(Z)$ with $\delta(A) = B$, then $\Delta(Z)$ is called *linear transitive*. An involutorial central dilatation σ (i.e. $\sigma^2 = id \neq \sigma$) with fixed point P is called *reflection at point P* .

The set of translations and central dilatations is the group of *dilatations* which can be described as the set collineations of an affine plane which any line to a parallel one.

A collineation α of an affine plane \mathfrak{A} is called *axial affinity*, if the set of fixed points of α comprises the points of a line a . The fixed lines of α are line a and a pencil of parallel lines Π_α . Affinity α is a *shear at line a* , if $a \in \Pi_\alpha$ and an *axial dilatation at a* , if $a \notin \Pi_\alpha$. If for a line z we have $z \in \Pi_\alpha$ collineation α is called *axial affinity in z -direction*. The set $A(a)$ of axial affinities with axis a is a group, alike the subset $A(a, z)$ of $A(a)$ with direction z . Group $A(a, z)$ is called *linear transitive* if for any pair $P, Q \in \mathcal{P} \setminus a$ whose connection line is parallel to z there exists an $\alpha \in A(a, z)$ with $\alpha(P) = Q$.

An axial affinity is uniquely determined by a pair of point and image point not on the axis.

1.1.3 Desarguesian affine planes

Let be $(K, +, \cdot)$ a skewfield (not necessary commutative field) and $\mathcal{P} = K^2$ and $\mathcal{G} = \{ \{(x, y) \in \mathcal{P} \mid y = mx + b\} \mid m, b \in K \} \cup \{ \{(x, y) \in \mathcal{P} \mid x = c\} \mid c \in K \}$
 The incidence structure $\mathfrak{A}(K) = (\mathcal{P}, \mathcal{G}, \in)$ is an affine plane.

Result 1.1 *An affine plane \mathfrak{A} is isomorphic to an affine plane $\mathfrak{A}(K)$ if for \mathfrak{A} the affine theorem of Desargues holds:*

For any three triples of points Z, A, A' ; Z, B, B' ; Z, C, C' collinear on three different lines (through Z) with parallel connections $\overline{AB} \parallel \overline{A'B'}$, $\overline{BC} \parallel \overline{B'C'}$ yields $\overline{AC} \parallel \overline{A'C'}$

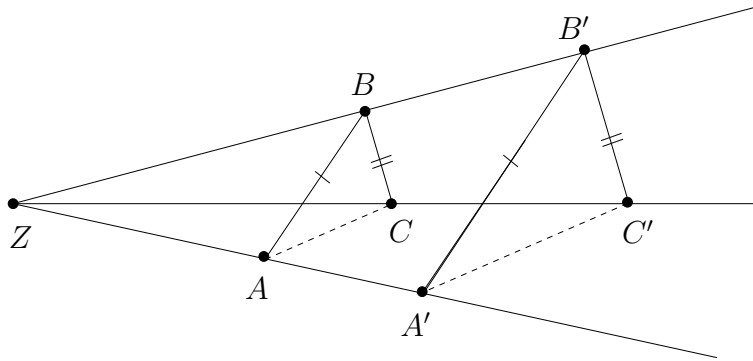

Figure 1.2: affine theorem of Desargues

An affine plane \mathfrak{A} is called **desarguesian** if the theorem of Desargues is valid for any configuration. Such a plane \mathfrak{A} is isomorphic to an affine plane $\mathfrak{A}(K)$ for a suitable skewfield K .

Result 1.2 *For two isomorphic skewfields K, K' the affine planes $\mathfrak{A}(K), \mathfrak{A}(K')$ are isomorphic.*

Result 1.3 *Any collineation ψ of the desarguesian affine plane $\mathfrak{A}(K)$ can be represented by*

$$\psi : (x, y) \rightarrow (a\kappa(x) + b\kappa(y) + r, c\kappa(x) + d\kappa(y) + s) \quad \text{with } a, b, c, d, r, s \in K \quad ad - bc \neq 0$$

and an isomorphism κ of skewfield K .

If $\kappa = id$ then ψ is called affinity.

Especially we get:

- a) $\kappa = id, a = d = 1, b = c = 0$ the translation $(x, y) \rightarrow (x + r, y + s)$,
- b) $\kappa = id, a \neq 0, b = c = r = s = 0, d = 1$ the axial affinity at the y-axis $(x, y) \rightarrow (ax, y)$,
- c) $\kappa = id, a = 1, b = r = s = 0, d = 1$ the shear at the y-axis $(x, y) \rightarrow (x, y + cx)$,
- d) $\kappa(x) = t^{-1}xt, a = t, b = c = r = s = 0, d = t$ the central dilatation at point $(0, 0)$
 $(x, y) \rightarrow (xt, yt)$,

Result 1.4 a) An affine plane \mathfrak{A} is desarguesian if and only if any central dilatation group $\Delta(P), P \in \mathcal{P}$, is linear transitive.

b) An affine plane \mathfrak{A} is desarguesian if and only if any group $A(a, z), a, z \in \mathcal{G}$, of axial affinities is linear transitive.

Result 1.5 The group of affinities operates transitively on the set of triangles (triples of non collinear points).

Result 1.6 The skewfield K of coordinates of a desarguesian affine plane $\mathfrak{A}(K)$ is of characteristic 2 (i.e. $1+1=0$) if there is one parallelogram with parallel diagonal lines.

1.1.4 Pappian affine planes

An affine plane $\mathfrak{A} := (\mathcal{P}, \mathcal{G}, \in)$ is called **pappian** if for any hexagon $P_1, P_2, P_3, Q_1, Q_2, Q_3$ with collinear triples of points P_1, P_2, P_3 and Q_1, Q_2, Q_3 on lines g and h respectively, but no point on both the lines, the following statement (theorem of Pappus) holds:

If two sides (of the hexagon) are parallel then the third one, too.

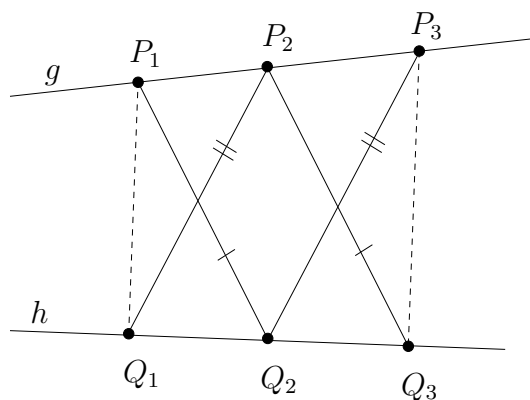

Figure 1.3: affine theorem of Pappus

Result 1.7 Any pappian affine plane \mathfrak{A} is isomorphic to a desarguesian affine plane $\mathfrak{A}(K)$ over a (commutative !) field K .

Remark: For a pappian affine plane the group of affinities comprises the set of central dilatations.

1.2 Projective planes

1.2.1 The axioms of a projective plane

Let be $\mathcal{P} \neq \emptyset$ a set, the set of *points*, and $\mathcal{G} \neq \emptyset$ a subset of the power set of \mathcal{P} , the set of *lines*. A point P is called *incident* with a line g , if $P \in g$.

The incidence structure $\mathfrak{P} := (\mathcal{P}, \mathcal{G}, \in)$ is called **projective plane** if the following axioms hold:

- P1:** For any pair of points P, Q there exists one and only one line g with $P, Q \in g$.
- P2:** For any pair of lines g, h there exists one and only one point P with $g \cap h = \{P\}$.
- P3:** There are four points, no three collinear (quadrilateral).

Three points P, Q, R are *collinear* if there is a line with $P, Q, R \in g$.

For $|\mathcal{P}| < \infty$ and $n := |g| - 1$ we have $|h| = n + 1$ for any line $h \in \mathcal{G}$. The integer n is called *order* of the finite projective plane $(\mathcal{P}, \mathcal{G}, \in)$.

From combinatorics we get: $|PC| = |\mathcal{G}| = n^2 + n + 1$.

Result 1.8 a) Let be $\mathfrak{A} = (\mathcal{P}, \mathcal{G}, \in)$ an affine plane and \mathcal{U} the set of classes of parallel lines on \mathcal{G} , then the incidence structure $\overline{\mathfrak{A}} := (\mathcal{P}', \mathcal{G}', \in)$ with $\mathcal{P}' := \mathcal{P} \cup \mathcal{U}$ and $\mathcal{G}' := \{g \cup u_g \mid g \in \mathcal{P}, u_g \in \mathcal{U} \text{ with } g \in u_g\} \cup \{\mathcal{U}\}$ is a projective plane. $\overline{\mathfrak{A}}$ is the **projective completion** of \mathfrak{A} .

b) Let be $\mathfrak{P} = (\mathcal{P}, \mathcal{G}, \in)$ a projective plane and $g_\infty \in \mathcal{G}$. Then the incidence structure $\overline{\mathfrak{P}} := (\mathcal{P}', \mathcal{G}', \in)$ with $\mathcal{P}' := \mathcal{P} \setminus g_\infty$ and $\mathcal{G}' := \{g \setminus g_\infty \mid g \in \mathcal{G} \setminus \{g_\infty\}\}$ is an affine plane.

1.2.2 Collineations of a projective plane

Let be $(\mathcal{P}, \mathcal{G}, \in)$ a projective plane and ψ a permutation of its point set \mathcal{P} which induces a permutation of the lines. ψ is called a *collineation* of \mathfrak{P} . A collineation π that fixes the points of a line g and any line through a fixed point P (pencil of lines) is called a *central collineation* or *perspectivity* with axis g and center P , short: $(g, P) - \text{perspectivity}$. In case of $P \in g$ π is called *elation* otherwise ($P \notin g$) *homology*. The set of central collineations with same axis g and center P form group $\Pi(g, P)$. The group $\Pi(g, p)$ is *linear transitive* if for any pair of points $A, B \in \mathcal{P} \setminus (g \cup \{P\})$ collinear with center P there exists a $\pi \in \Pi(g, P)$ such that $\pi(A) = B$ (For short: \mathfrak{A} is $(g, P) - \text{transitive}$). The group Π generated by the central collineations is the *group of projectivities*.

1.2.3 Desarguesian projective planes

Let be $(K, +, \cdot)$ a skewfield and $\mathcal{P} = K^2 \cup K \cup \{\infty\}$, $\infty \notin K$, and
 $\mathcal{G} = \{ \{(x, y) \in \mathcal{P} \mid y = mx + b\} \cup \{(m)\} \mid m, b \in K\}$
 $\cup \{ \{(x, y) \in \mathcal{P} \mid x = c\} \cup \{(\infty)\} \mid c \in K\}$
 $\cup \{(m) \mid m \in K \cup \{\infty\}\}$.

Incidence structure $\overline{\mathfrak{A}(K)} := (\mathcal{P}, \mathcal{G}, \in)$ is a projective plane.

$\overline{\mathfrak{A}(K)}$ is the *projective completion* of affine plane $\mathfrak{A}(K)$, $g_\infty := \{(m) \mid m \in K \cup \{\infty\}\}$ the *line at infinity* of $\overline{\mathfrak{A}(K)}$ and an arbitrary point $P \in g_\infty$ is called a *point at infinity*.

Result 1.9 A projective plane \mathfrak{P} is isomorphic to a projective plane $\overline{\mathfrak{A}(K)}$ if for \mathcal{P} the projective Theorem of Desargues holds:

For any three triples of points Z, A, A' ; Z, B, B' ; Z, C, C' collinear on three different lines (through Z) the following points D, E, F with $\{D\} := \overline{AB} \cap \overline{A'B'}$, $\{E\} := \overline{BC} \cap \overline{B'C'}$, $\{F\} := \overline{AC} \cap \overline{A'C'}$, are collinear.

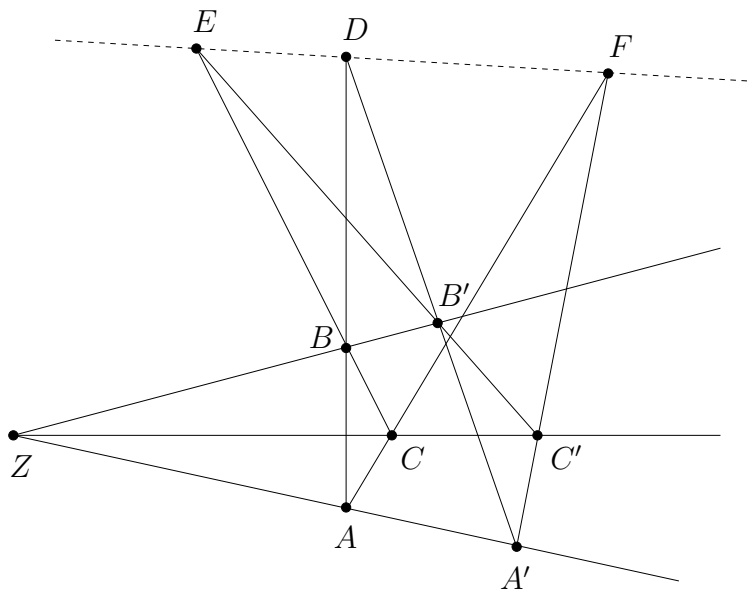

Figure 1.4: projective theorem of Desargues

A projective plane \mathfrak{P} is called **desarguesian** if the theorem of Desargues is valid for any configuration. Such a plane \mathfrak{P} is isomorphic to an projective plane $\overline{\mathfrak{A}(K)}$ for a suitable skewfield K .

Result 1.10 Let be \mathfrak{P} a desarguesian projective plane, g, h two lines and \mathfrak{P}_g and \mathfrak{P}_h the affine planes with respect to the lines g and h as lines at infinity. Then \mathfrak{P}_g and \mathfrak{P}_h are isomorphic desarguesian affine planes.

1.2.4 Homogeneous coordinates of a desarguesian plane

Let be $(K, +, \cdot)$ a skewfield, K^3 the 3-dimensional right vector space on K and $\langle (x_1, x_2, x_3) \rangle$ the 1-dimensional subspace determined by $\mathbf{0} \neq (x_1, x_2, x_3) \in K^3$. For $\mathcal{P} := \{\langle (x_1, x_2, x_3) \rangle \mid \mathbf{0} \neq (x_1, x_2, x_3) \in K^3\}$ and $\mathcal{G} := \{\{\langle (x_1, x_2, x_3) \rangle \in \mathcal{P} \mid ax_1 + bx_2 + cx_3 = 0\} \mid \mathbf{0} \neq (a, b, c) \in K^3\}$ the incidence structure $\mathfrak{P}(K) := (\mathcal{P}, \mathcal{G}, \in)$ is a projective plane.

Result 1.11 $\mathfrak{P}(K)$ is isomorphic to the desarguesian projective plane $\overline{\mathfrak{A}(K)}$.

$\mathfrak{P}(K)$ is a representation of $\overline{\mathfrak{A}(K)}$ in homogeneous coordinates.

If one chooses the isomorphism mentioned in the result above in such a way that the line at infinity of $\overline{\mathfrak{A}(K)}$ has the equation $x_3 = 0$ then we get the following spatial representation $(\mathcal{P}', \mathcal{G}', \in)$ of the affine plane $\mathfrak{A}(K)$:

$$\begin{aligned} \mathcal{P}' &:= \{\langle (x, y, 1) \rangle \mid x, y \in K\} \\ \mathcal{G}' &:= \{\{\langle (x, y, 1) \rangle \mid ax + by + c = 0\} \mid \mathbf{0} \neq (a, b) \in K^2, c \in K\} \end{aligned}$$

1.2.5 Collineations of a desarguesian projective plane

Let be $(K, +, \cdot)$ a skewfield, \mathfrak{V} a right vector space over K and ψ a bijection from \mathfrak{V} onto itself with

$\psi(\mathbf{x}k + \mathbf{y}l) = \psi(\mathbf{x})\kappa(k) + \psi(\mathbf{y})\kappa(l)$ where κ is an automorphism of the skewfield K . Then ψ is called a *semi linear map* of \mathfrak{V} . The set of semi linear maps of \mathfrak{V} is the group $\Gamma L(\mathfrak{V}, K)$. The linear maps (i.e. $\kappa = id$) are a subgroup $GL(\mathfrak{V}, K)$ of $\Gamma L(\mathfrak{V}, K)$.

In case of finite dimension $n \geq 1$ of \mathfrak{V} one uses the following assignments:

$$\Gamma L(n, K) := \Gamma L(\mathfrak{V}, K) \text{ and } GL(n, K) := GL(\mathfrak{V}, K).$$

For example: $\psi \in \Gamma L(2, K)$ has the following representation:

$$(x_1, x_2) \rightarrow (a\kappa(x_1) + b\kappa(x_2), c\kappa(x_1) + d\kappa(x_2)) \text{ with } ad - bc \neq 0.$$

Any semi linear map ψ of vector space K^3 induces a collineation of the desarguesian projective plane $\mathfrak{P}(K)$. Group $\Gamma L(3, K)$ induces the collineation group $P\Gamma L(3, K)$ and $GL(3, K)$ induces $PGL(3, K)$.

Result 1.12 a) $P\Gamma L(3, K)$ is the set of all collineations of $\mathfrak{P}(K)$.

b) $PGL(3, K)$ is the set of all projectivities of $\mathfrak{P}(K)$.

Result 1.13 For a desarguesian projective plane $PGL(3, K)$ operates transitive on the set of quadrangles in “general position” (i.e. no three points are collinear).

1.2.6 Pappian projective planes

A projective plane $\mathfrak{P} = (\mathcal{P}, \mathcal{G}, \in)$ is called **pappian** if \mathfrak{P} fulfills the (projective) Theorem of Pappus :

Let be $P_1, P_2, P_3, Q_1, Q_2, Q_3$ a hexagon with collinear triples of points P_1, P_2, P_3 and Q_1, Q_2, Q_3 on two lines g and h respectively, but no point on both the lines. Then the following three points

$A := \overline{P_1Q_2} \cap \overline{P_2Q_1}$, $B := \overline{P_1Q_3} \cap \overline{P_3Q_1}$, $C := \overline{P_2Q_3} \cap \overline{P_3Q_2}$ are collinear.

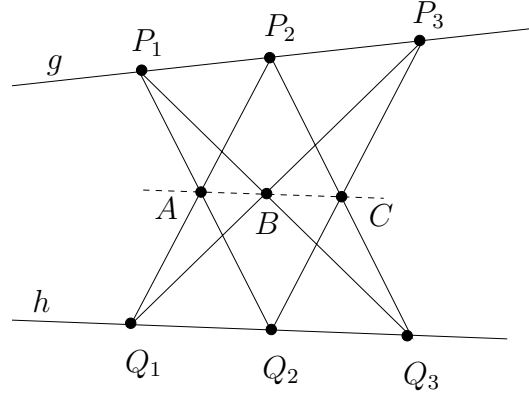

Figure 1.5: projective Theorem of Pappus

Result 1.14 Any pappian projective plane \mathfrak{P} is isomorphic to a desarguesian projective plane $\mathfrak{P}(K)$ over a (commutative !) field K .

Result 1.15 (PICKERT, see [KA'73])

A projective plane is pappian if and only if the theorem of Pappus is fulfilled for hexagons on two fixed lines g, h .

1.2.7 The groups $PGL(2, K)$, $PGL(2, K)$ and $PSL(2, K)$

Let be $(K, +, \cdot)$ a field and

$$\mathfrak{P}_1(K) := \{ \langle (x_1, x_2) \rangle \mid \mathbf{0} \neq (x_1, x_2) \in K^2 \} \quad \text{and} \quad \overline{\mathfrak{A}_1(K)} := K \cup \{\infty\}$$

the homogeneous and inhomogeneous representation of the projective line on K , respectively.

Because of their definition $PGL(2, K)$ and $PGL(2, K)$ are groups of permutations of $\mathfrak{P}_1(K)$. For any $\psi \in PGL(2, K)$ there exist $a, b, c, d \in K$ and an automorphism κ of field K such that

$$\psi : \langle (x_1, x_2) \rangle \rightarrow \langle (a\kappa(x_1) + b\kappa(x_2), c\kappa(x_1) + d\kappa(x_2)) \rangle \quad \text{with } ad - bc \neq 0.$$

With the bijection

$\langle (1, 0) \rangle \rightarrow \infty$, $\langle (x, 1) \rangle \rightarrow x$ from $\mathfrak{P}_1(K)$ onto $K \cup \{\infty\}$ we recognize that ψ induces on $K \cup \{\infty\}$ the permutation ψ' with the following effect:

$$\infty \rightarrow \begin{cases} \frac{a}{c} & , \text{ if } c \neq 0 \\ \infty & , \text{ if } c = 0 \end{cases}, \quad x \rightarrow \begin{cases} \frac{a\kappa(x) + b}{c\kappa(x) + d} & , \text{ if } c\kappa(x) + d \neq 0 \\ \infty & , \text{ if } c\kappa(x) + d = 0 \end{cases} \quad \text{for } x \in K.$$

A slight abbreviation for ψ' is $x \rightarrow \frac{a\kappa(x) + b}{c\kappa(x) + d}$, $ad - bc \neq 0$.

ψ' is called *fractional semi linear mapping* and in case of $\kappa = id$ *fractional linear mapping*.

Using the abbreviation above we have:

$$P\Gamma L(2, K) = \left\{ x \rightarrow \frac{a\kappa(x) + b}{c\kappa(x) + d} \mid a, b, c, d \in K, ad - bc \neq 0, \kappa \text{ automorphism of } K \right\}.$$

$$PGL(2, K) = \left\{ x \rightarrow \frac{ax + b}{cx + d} \mid a, b, c, d \in K, ad - bc \neq 0 \right\}.$$

The set

$$PSL(2, K) := \left\{ x \rightarrow \frac{ax + b}{cx + d} \mid a, b, c, d \in K, ad - bc = 1 \right\}.$$

is a special subgroup of $PGL(2, K)$.

Result 1.16 a) $PGL(2, K)$ operates sharply 3-transitively on $K \cup \{\infty\}$, i.e. for any pair of three elements x_1, x_2, x_3 and $x'_1, x'_2, x'_3 \in K \cup \{\infty\}$ there exists one and only one $\pi \in PGL(2, K)$ such that $\pi(x_i) = x'_i$ for $i = 1, 2, 3$.

b) $PSL(2, K)$ operates 2-transitively on $K \cup \{\infty\}$, i.e. for any two pairs x_1, x_2 and x'_1, x'_2 of $K \cup \{\infty\}$ there is one and only one $\pi \in PSL(2, K)$ such that $\psi(x_1) = x'_1$ and $\psi(x_2) = x'_2$

1.2.8 Basic 1-dimensional projective configurations

Through this section \mathfrak{P} is always a projective plane.

A **basic 1-dimensional projective configuration** (for short: basic configuration) of \mathfrak{P} is either the point set of a fixed line or the set of lines through a fixed point.

Let be g, h two (different) lines and Z a point $\notin g \cup h$. The map π which sends any point of line g onto a point of line h by $\pi(P) = \overline{PZ} \cap h$ is called a **perspective mapping from g onto h** . The set of perspective mappings from line g onto line h is $\Pi(g \rightarrow h)$.

For a finite sequence $g = g_0, g_1, \dots, g_n = h$ of lines (of \mathfrak{P}) and $\pi_i \in \Pi(g_{i-1} \rightarrow g_i)$, $i = 1, 2, \dots, n$, the mapping $\pi_n \pi_{n-1} \cdots \pi_1$ is a **projective mapping from g onto h** .

Let be $\mathfrak{B}(P)$ and $\mathfrak{B}(Q)$ two pencils of lines and a a line $\neq \overline{PQ}$. Then the mapping π from $\mathfrak{B}(P)$ onto $\mathfrak{B}(Q)$ with $\pi(g) = \overline{(g \cap a)Q}$ is called a *perspective mapping from $\mathfrak{B}(P)$ onto $\mathfrak{B}(Q)$* .

A *projective mapping from $\mathfrak{B}(P)$ onto $\mathfrak{B}(Q)$* is defined analogously to the projective mapping of points on lines.

The set of projective mappings of a basic 1-dimensional configuration onto itself is a group and the following is true:

Result 1.17 a) *The group of projective mappings of a basic 1-dimensional projective configuration onto itself operates 3-transitively. ([LE'65], p. 29)*

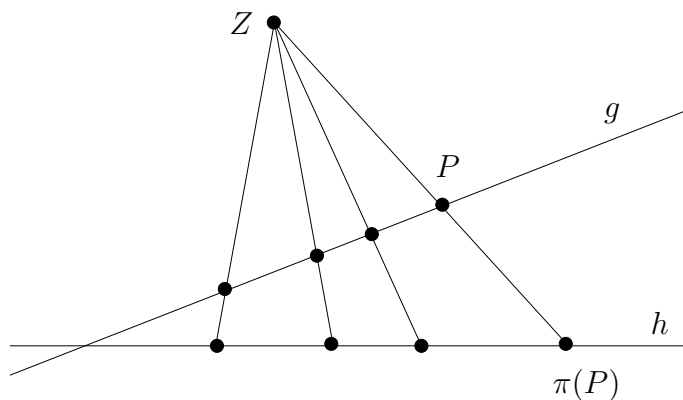
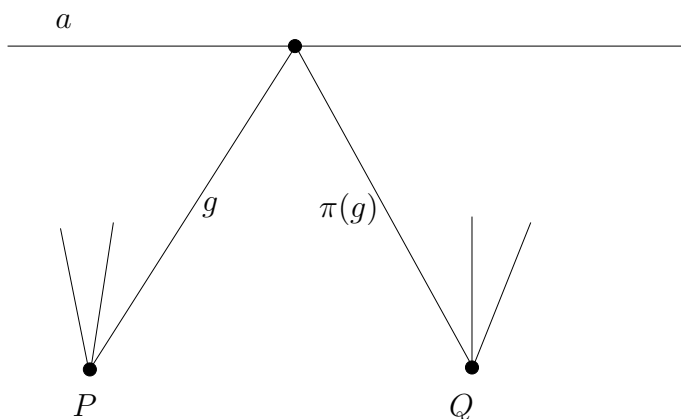
Figure 1.6: Perspective mapping from line g onto line h Figure 1.7: Perspective mapping from pencil $\mathfrak{B}(P)$ onto $\mathfrak{B}(Q)$

- b) *The restriction of a projective collineation (projectivity) onto a basic configuration is a projective mapping ([LE'65], p. 33).*
- c) *For a Moufang plane any projective mapping of a line can be extended to a projective collineation ([LE'65], p. 30).*
- d) *For a desarguesian plane \mathfrak{P} with a projective mapping π of a line g onto a line h (pencils $\mathfrak{B}(P)$ and $\mathfrak{B}(Q)$ respectively) there exists a line l (pencil $\mathfrak{B}(R)$) such that π is a product of a perspective mapping from g onto l (pencil $\mathfrak{B}(P)$ onto $\mathfrak{B}(R)$) and a perspective mapping from l onto h (pencil $\mathfrak{B}(R)$ onto $\mathfrak{B}(Q)$) ([LE'65], p.42).*
- e) *A projective plane is pappian if and only if any projective mapping of a basic configuration onto itself with three fixed points (fixed lines) is the identity ([BR'76], p. 42-47).*
- f) *For a pappian projective plane any projective mapping of a basic configuration onto itself that exchanges two points is an involution ([LE'65], p. 55).*
- g) *For a pappian plane any projective mapping of a line g onto a line $h \neq g$ (pencil $\mathfrak{B}(P)$ and $\mathfrak{B}(Q) \neq \mathfrak{B}(P)$) with fixed point $g \cap h$ (fixed line \overline{PQ}) is perspective*

([LE'65], p. 49).

- h) For pappian plane over a field K the group of projective mappings of a basic configuration onto itself is isomorphic to $PGL(2, K)$ (as permutation group of $K \cup \{\infty\}$) ([LI'78], p. 113).*

Chapter 2

OVALS AND CONICS

Literature: [BR'76], [DE'68], [HU,PI'73], [LE'65], [LI'78], [PI'55]

2.1 Oval, parabolic and hyperbolic curve

An oval in a projective or affine plane is a point set which has similar properties considering incidence with lines as a circle or ellipse in the real euclidean plane.

Definition 2.1 *A non empty point set \mathfrak{o} of a projective or affine plane is called **oval** if the following properties are fulfilled:*

(o1) *Any line meets \mathfrak{o} in at most two points.*

(o2) *For any point $P \in \mathfrak{o}$ there is one and only one line g such that $g \cap \mathfrak{o} = \{P\}$.*

A line g is a exterior or tangent or secant line of the oval if $|g \cap \mathfrak{o}| = 0$ or $|g \cap \mathfrak{o}| = 1$ or $|g \cap \mathfrak{o}| = 2$ respectively.

Example 2.1 *For the real affine plane $\mathfrak{A}(\mathbb{R})$ and the real projective plane $\overline{\mathfrak{A}(\mathbb{R})}$ respectively the following point sets are ovals:*

a) $\{(x, y) \mid x^2 + y^2 = 1\}$ is an oval in $\mathfrak{A}(\mathbb{R})$ and $\overline{\mathfrak{A}(\mathbb{R})}$.

b) $\{(x, y) \mid x^4 + y^4 = 1\}$ is an oval in $\mathfrak{A}(\mathbb{R})$ and $\overline{\mathfrak{A}(\mathbb{R})}$.

c) $\{(x, y) \mid y = x^2\} \cup \{(\infty)\}$ is an oval in $\overline{\mathfrak{A}(\mathbb{R})}$.

d) $\{(x, y) \mid y = \cosh x\} \cup \{(\infty)\}$ is an oval in $\overline{\mathfrak{A}(\mathbb{R})}$ (see [HA'84]).

e) $\{(x, y) \mid y = \frac{1}{x}, x \neq 0\} \cup \{(0), (\infty)\}$ is an oval in $\overline{\mathfrak{A}(\mathbb{R})}$.

f) $\{(x, y) \mid y = \frac{1}{x^3}, x \neq 0\} \cup \{(0), (\infty)\}$ is an oval in $\overline{\mathfrak{A}(\mathbb{R})}$.

The following definition generalizes the parabola and hyperbola analogously.

Definition 2.2 Let \mathfrak{A} be an affine plane, $\overline{\mathfrak{A}}$ its projective completion and g_∞ the line at infinity.

- a) A point set \mathfrak{p} of \mathfrak{A} is a **parabolic curve** if there is a point $U \in g_\infty$ such that $\mathfrak{o} := \mathfrak{p} \cup \{U\}$ is an oval in $\overline{\mathfrak{A}}$. U is the point at infinity of \mathfrak{p} .
- b) A point set \mathfrak{h} of \mathfrak{A} is a **hyperbolic curve** if there are two points $U, V \in g_\infty$ such that $\mathfrak{o} := \mathfrak{h} \cup \{U, V\}$ is an oval in $\overline{\mathfrak{A}}$. U, V are the points at infinity of \mathfrak{h} .

Example 2.2 For the real affine plane $\mathfrak{A}(\mathbb{R})$ the following statements are true:

- a) $\{(x, y) \mid y = x^2\}$ is a parabolic curve in $\mathfrak{A}(\mathbb{R})$ with $U = (\infty)$.
- b) $\{(x, y) \mid y = \cosh x\}$ is a parabolic curve in $\mathfrak{A}(\mathbb{R})$ with $U = (\infty)$.
- c) $\{(x, y) \mid y = \frac{1}{x}, x \neq 0\}$ is a hyperbolic curve in $\mathfrak{A}(\mathbb{R})$ with $U = (\infty), V = (0)$.
- d) $\{(x, y) \mid x^2 - y^2 = 1, x \neq 0\}$ is a hyperbolic curve in $\mathfrak{A}(\mathbb{R})$ with $U = (1), V = (-1)$.

Remark 2.1 The point at infinity of a parabolic curve is not in any case uniquely determined !

Apparently the following statement holds:

Lemma 2.1 a) Let be \mathfrak{A} an affine plane, φ a collineation, \mathfrak{o} an oval, \mathfrak{p} a parabolic curve and \mathfrak{h} a hyperbolic curve. Then $\varphi(\mathfrak{o})$ is an oval, $\varphi(\mathfrak{p})$ a parabolic curve and $\varphi(\mathfrak{h})$ a hyperbolic curve, too.

- b) Let be \mathfrak{P} a projective plane, φ a collineation and \mathfrak{o} an oval. Then $\varphi(\mathfrak{o})$ is an oval, too.

2.2 The ovals \mathfrak{c}_1 and \mathfrak{c}_2

While searching for ovals in an arbitrary pappian affine plane $\mathfrak{A}(K)$ or projective plane $\overline{\mathfrak{A}(K)}$ one recognizes for example that the set $\mathfrak{h} := \{(x, y) \mid x^2 + y^2 = 1\}$ for $K = \mathbb{C}$ (complex numbers) is not an oval in $\mathfrak{A}(\mathbb{C})$. But \mathfrak{h} is a hyperbolic curve with points at infinity $\{(i), (-i)\}$ (in $\overline{\mathfrak{A}(\mathbb{C})}$). Another strange phenomenon is: Curve \mathfrak{h} gives not in any case rise to an oval in the projective completion. For example, if $\text{Char}K = 2$ equation $x^2 + y^2 = 1$ is equivalent to $x + y = 1$ which describes a line and there is no chance for extending \mathfrak{h} to an oval in $\overline{\mathfrak{A}(K)}$.

But the following statement is true:

Lemma 2.2 Let K be a field. Then

$\mathfrak{c}_1 := \{(x, y) \mid y = x^2\} \cup \{(\infty)\}$ and $\mathfrak{c}_2 := \{(x, y) \mid y = \frac{1}{x}, x \neq 0\} \cup \{(0), (\infty)\}$
are ovals in $\overline{\mathfrak{A}(K)}$.

Proof:

For \mathfrak{c}_1 : The equation $y = m(x - x_0) + x_0^2$ describes a line g meeting point $(x_0, x_0^2) \in \mathfrak{c}_1$ which contains not point (∞) . For point $P = (\bar{x}, \bar{y}) \in \mathfrak{c}_1 \cap g$ we have $m(\bar{x} - x_0) + x_0^2 = \bar{x}^2$. In case of $CharK \neq 2$ we get $\bar{x}_{1/2} = \frac{m}{2} \pm (x_0 - \frac{m}{2})$. That means: $|\mathfrak{c}_1 \cap g| = 1$ if and only if $m = 2x_0$.

In case of $CharK = 2$ we get $\bar{x}_1 = x_0$ and $\bar{x}_1 = m + x_0$. That means: $|\mathfrak{c}_1 \cap g| = 1$ if and only if $m = 0$.

With $\mathfrak{c}_1 \cap g_\infty = (\infty)$ the result is in any case: \mathfrak{c}_1 is an oval in $\overline{\mathfrak{A}(K)}$.

For \mathfrak{c}_2 : The equation $y = m(x - x_0) + \frac{1}{x_0}$ with $m, x_0 \neq 0$ describes a line through point $(x_0, \frac{1}{x_0}) \in \mathfrak{c}_2$ which does not contain the points (0) and (∞) . For point $P = (\bar{x}, \bar{y}) \in \mathfrak{c}_2 \cap g$ we have $(m + \frac{1}{xx_0})(\bar{x} - x_0) = 0$. We get $\bar{x} = x_0$ or $\bar{x} = -\frac{1}{mx_0}$ which means $|\mathfrak{c}_2 \cap g| = 1$ if and only if $m = -\frac{1}{x_0^2}$. Hence \mathfrak{c}_2 is an oval. (The tangent lines at point (0) and (∞) are $y = 0$ and $x = 0$ respectively.) \square

From the proof of Theorem 2.2 we learn that in case of $CharK = 2$ all tangent lines meet a fixed point which leads to the following definition.

Definition 2.3 a) If all tangent lines of an oval \mathfrak{o} meet at a point N then N is called the **knot** of oval \mathfrak{o} .

b) A knot of an oval \mathfrak{o} is called **complete** if any line passing N is a tangent line of \mathfrak{o} .

Remark 2.2 a) In case of $CharK = 2$ oval \mathfrak{c}_1 has knot (0) and oval \mathfrak{c}_2 the knot $(0, 0)$.

b) If additionally to $CharK = 2$ any element of K is a square (K is perfect) then the knots of the ovals \mathfrak{c}_1 and \mathfrak{c}_2 are complete.

With the aid of the following theorem we find additional ovals.

Theorem 2.3 (knot exchange) Let be \mathfrak{P} a projective plane, \mathfrak{o} an oval of \mathfrak{P} with a complete knot N and $U \in \mathfrak{o}$. Then $\mathfrak{o}' := (\mathfrak{o} \setminus \{U\}) \cup \{N\}$ is an oval, too.

Proof: The line \overline{NU} is a tangent line for the set \mathfrak{o}' at point N . For $P \in \mathfrak{o}' \setminus \{N\}$ line \overline{PU} is a tangent line of set \mathfrak{o}' at point P . Any other line through P meets \mathfrak{o}' at a further point. Hence \mathfrak{o}' is an oval, too. \square

In case of a perfect field K of $CharK = 2$ the following sets are ovals in $\overline{\mathfrak{A}(K)}$, too.

$$\mathfrak{c}'_1 := \{(x, y) \mid y = x^2\} \cup \{(0)\},$$

$$\mathfrak{c}'_2 := \{(x, y) \mid y = \frac{1}{x}, x \neq 0\} \cup \{(0, 0), (0)\} \quad \text{and}$$

$$\mathfrak{c}''_2 := \{(x, y) \mid y = \frac{1}{x}, x \neq 0\} \cup \{(0, 0), (\infty)\}.$$

(Because of Theorem 2.3) Simple examples of perfect fields are the finite fields of even order.

From Theorem 2.3 we learn that the point at infinity of a parabolic curve is not uniquely determined.

2.3 Properties of the ovals \mathbf{c}_1 and \mathbf{c}_2

In order to describe the relation between the ovals \mathbf{c}_1 and \mathbf{c}_2 we give the following definition.

Definition 2.4 *Two ovals \mathfrak{o} and \mathfrak{o}' of a projective (affine) plane are called*

*a) **equivalent** if there exists a collineation φ with $\varphi(\mathfrak{o}) = \mathfrak{o}'$,*

*b) **projectively equivalent (affinely equivalent)** if there exists a projectivity (affinity) π with $\pi(\mathfrak{o}) = \mathfrak{o}'$.*

Lemma 2.4 *The ovals \mathbf{c}_1 and \mathbf{c}_2 are projectively equivalent.*

Proof: The perspectivity π with axis $x = 1$ and center $(-1, 0)$ which maps $(0, 0)$ onto (0) acts on K^2 , $x \neq 0$ (inhomogeneous model) as $(x, y) \rightarrow (\frac{1}{x}, \frac{y}{x})$. Obviously: $\pi(\mathbf{c}_1) = \mathbf{c}_2$. \square

The projective equivalence can be deduced within the homogeneous model, too:

From $x = \frac{x_1}{x_3}$, $y = \frac{x_2}{x_3}$ (see Section 1.2.4) we get

$$\mathbf{c}_1 = \{ \langle (x_1, x_2, x_3) \rangle \in \mathcal{P} \mid x_1^2 = x_2 x_3 \} \quad \text{and} \quad \mathbf{c}_2 = \{ \langle (x_1, x_2, x_3) \rangle \in \mathcal{P} \mid x_3^2 = x_1 x_2 \}.$$

The projectivity $\pi : \langle (x_1, x_2, x_3) \rangle \rightarrow \langle (x_3, x_2, x_1) \rangle$ maps oval \mathbf{c}_1 onto oval \mathbf{c}_2 .

The following theorem shows that ovals \mathbf{c}_1 and \mathbf{c}_2 are highly symmetric.

Lemma 2.5 *Let K be a field and $(t) \rightarrow (t, t^2)$, $\infty \rightarrow (\infty)$ the natural parameterization of oval $\mathbf{c}_1 = \{(x, y) \in K^2 \mid y = x^2\} \cup \{(\infty)\}$ in $\mathfrak{A}(K)$. The group $\Pi(\mathbf{c}_1)$ of projectivities (of $\mathfrak{A}(K)$) which leave \mathbf{c}_1 invariant induces on $K \cup \{\infty\}$ the fractional linear mappings $t \rightarrow \frac{at+b}{ct+d}$, $ad - bc \neq 0$. That means group $\Pi(\mathbf{c}_1)$ operates on oval \mathbf{c}_1 sharply 3-transitive.*

Proof: Any mapping $(x, y) \rightarrow (ax + b, a^2y + 2abx + b^2)$, $a \neq 0$ of K^2 onto itself induces in $\mathfrak{A}(K)$ a projectivity π_{ab} which leaves (obviously) oval \mathbf{c}_1 invariant. π_{ab} has on the parameter space the effect $t \rightarrow at + b$, $\infty \rightarrow \infty$. The projectivity σ_1 with effect $(x, y) \rightarrow (\frac{x}{y}, \frac{1}{y})$, $y \neq 0$ on K^2 exchanges the points $(0, 0)$ and (∞) and leaves oval \mathbf{c}_1 invariant. σ_1 induces on the parameter set the mapping $t \rightarrow \frac{1}{t}$ for $t \neq 0$ and $0 \rightarrow \infty$, $\infty \rightarrow 0$. The projectivities π_{ab} and σ_1 generate on the set $K \cup \{\infty\}$ the group of the fractional linear mappings.

Let G be the group generated by π_{ab} and σ_1 . Then $G = \Pi(\mathbf{c}_1)$, because: From $\pi' \in \Pi(\mathbf{c}_1) \setminus G$ we would get a projectivity $\pi'' \neq id$ with fixpoints $(0, 0), (1, 1), (\infty)$

which leaves oval \mathfrak{c}_1 invariant (G operates 3-transitively on \mathfrak{c}_1 !). The tangent lines at $(0, 0)$ and (∞) are fixed. Hence (0) is a further fixpoint. But a projectivity which fixes 4 points in general position is the identity (see [HU,PI'73], p.32). This is a contradiction to $\pi'' \neq id$. \square

The main result of Theorem 2.5 is also true for oval \mathfrak{c}_2 because of their equivalence. The existence of involutions (reflections) in $\Pi(\mathfrak{c}_2)$ gives the possibility to characterize \mathfrak{c}_2 by reflections. First a definition.

Definition 2.5 *An oval \mathfrak{o} of a projective plane \mathfrak{P} is called **symmetric to a point** $P \notin \mathfrak{o}$ if there exists an involutory perspectivity with center P which leaves \mathfrak{o} invariant.*

Lemma 2.6 *Let be \mathfrak{o} an oval of a pappian projective plane $\overline{\mathfrak{A}(K)}$ containing points $(0), (\infty), (1, 1)$ and point $(0, 0)$ is the intersection of the tangent lines at (0) and (∞) . Then \mathfrak{o} is the oval $\mathfrak{c}_2 := \{(x, y) \mid y = \frac{1}{x}, x \neq 0\} \cup \{(0), (\infty)\}$ if and only if \mathfrak{o} is symmetric to any point $P \in g_\infty \setminus \mathfrak{o}$.*

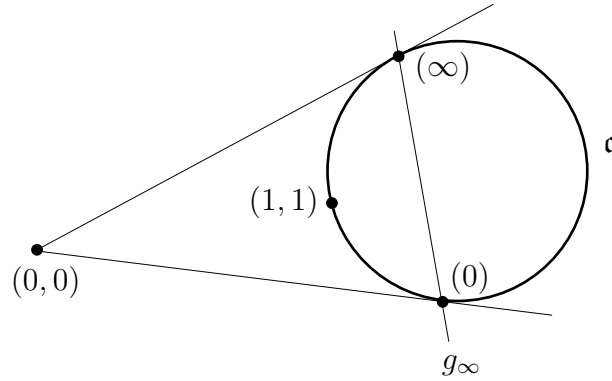

Figure 2.1: An oval symmetric to points on a secant line

Proof: I) In case of $\mathfrak{o} = \mathfrak{c}_2$ and $m \in K \setminus \{0\}$ the involutory perspectivity σ_m which has on K^2 the effect $(x, y) \rightarrow (\frac{y}{m}, mx)$ leaves oval \mathfrak{o} invariant. The center of σ_m is point $(-m) \in g_\infty$. Hence \mathfrak{o} is symmetric to any point of $g_\infty \setminus \mathfrak{o}$.

II) Let the oval \mathfrak{o} be symmetric to any point of $g_\infty \setminus \mathfrak{o}$ and $m \in K, m \neq 0$. There is exactly one involutory perspectivity σ_m with center $(-m)$ which fixes $(0, 0)$ and permutes the points $(0), (\infty)$ (The assumption that there exists a perspectivity $\sigma'_m \neq \sigma_m$ with the same properties leads to a contradiction.) Hence σ_m has on K^2 the effect $(x, y) \rightarrow (\frac{y}{m}, mx)$ and from $\sigma_m((1, 1)) = (\frac{1}{m}, m)$ for any $m \in K \setminus \{0\}$ we get $\mathfrak{o} = \mathfrak{c}_2$. \square

2.4 Oval conics and their properties

The characterization shown in Lemma 2.6 gives rise to a coordinate free definition of an oval (not degenerated) conic .

Definition 2.6 An oval \mathfrak{o} of a pappian projective plane is called **oval conic** if the following property (SS) is given

(SS) \mathfrak{o} is symmetric to any point $P \in g \setminus \mathfrak{o}$ of a secant line g .

Because of Lemma 2.4 and Lemma 2.6 we get:

Lemma 2.7 For a projective plane $\overline{\mathfrak{A}(K)}$ the ovals $\mathfrak{c}_1, \mathfrak{c}_2$ and all their equivalent images are oval conics.

It makes no sense to extend the definition of an oval conic to arbitrary desarguesian planes because for a non commutative skewfield K both point sets \mathfrak{c}_1 (ARTZY [AR'71]) and \mathfrak{c}_2 (BERZ [BZ'62]) are no ovals in $\overline{\mathfrak{A}(K)}$. And a desarguesian plane \mathfrak{P} which contains an oval with the typical property (SS) is already pappian (see BUEKENHOUT [BU'69], 4.5, MÄURER [MÄ'81], 4.1).

Theorem 2.8 (projective equivalence of conics) Let \mathfrak{P} be a pappian projective plane.

- a) For any three non collinear points U, V, E , any line u through U and any line v through V both different from $\overline{UV}, \overline{UE}, \overline{VE}$ there exists exactly one oval conic containing points U, V, E with tangent line u at point U and tangent line v at V .
- b) Any two oval conics $\mathfrak{c}, \mathfrak{c}'$ of \mathfrak{P} are projectively equivalent.

Proof: a) \mathfrak{P} can be described as $\overline{\mathfrak{A}(K)}$ such that $U = (0), V = (\infty), E = (1, 1)$ and $u \cap v = \{(0, 0)\}$. From Lemma 2.6 we get: The conic with properties assumed is \mathfrak{c}_2 .

b) We describe \mathfrak{P} as $\overline{\mathfrak{A}(K)}$ such that $\mathfrak{c} = \mathfrak{c}_2$. Let be g the secant line of \mathfrak{c}' containing its points of symmetry and let be $g \cap \mathfrak{c}' = \{U, V\}$ and u the tangent at U , v the tangent at V and E an arbitrary point of $\mathfrak{c} \setminus \{U, V\}$. There exists a projectivity π with $\pi(U) = (0), \pi(V) = (\infty), \pi(E) = (1, 1)$. Lemma 2.6 shows: $\pi(\mathfrak{c}') = \mathfrak{c}_2 = \mathfrak{c}$. \square

With the aid of Lemma 2.5 one proves the following statement.

Theorem 2.9 (symmetries of a conic) Let be \mathfrak{c} an oval conic of a pappian plane \mathfrak{P} and K a coordinate field of \mathfrak{P} .

- a) The group $\Pi(\mathfrak{c})$ of projectivities which leave \mathfrak{c} invariant is isomorphic to $PGL(2, K)$. $\Pi(\mathfrak{c})$ operates sharply 3-transitive on \mathfrak{c} .
- b) \mathfrak{c} is symmetric to any point $P \in \mathfrak{c}$ which is in case of $\text{Char} K = 2$ different from the knot of \mathfrak{c} .

The importance of statement a) of the previous theorem shows the following result.

Result 2.10 (TITS [TI'62], 3.1) Let be \mathfrak{o} an oval of a pappian projective plane \mathfrak{P} and $\Pi(\mathfrak{o})$ the group of projectivities which leave \mathfrak{o} invariant.

- a) \mathfrak{o} is an oval conic if and only if $\Pi(\mathfrak{o})$ operates 3-transitively on \mathfrak{o} .

b) In case of a **finite plane**: \mathfrak{o} is an oval conic if and only if $\Pi(\mathfrak{o})$ operates **2-transitively** on \mathfrak{o} .

For the proof of Theorem 2.12 we need the following statement which can be proved simply by calculation.

Lemma 2.11 (quadrilateral on a hyperbola) Let K be a field and $P_i = (x_i, y_i), i = 1, \dots, 4$ four points of the affine plane $\mathfrak{A}(K)$ with $x_i \neq x_k, y_i \neq y_k$ for $i \neq k$. The points P_1, P_2, P_3, P_4 lie on a hyperbola $y = \frac{a}{x-b} + c$ if and only if

$$\frac{(y_4 - y_1)(x_4 - x_2)}{(x_4 - x_1)(y_4 - y_2)} = \frac{(y_3 - y_1)(x_3 - x_2)}{(x_3 - x_1)(y_3 - y_2)}.$$

(See Section 5.3.3, too.)

The following theorems contain properties of ovals typical for conics.

Theorem 2.12 (6-point-PASCAL) Let \mathfrak{o} be an oval of a pappian projective plane. \mathfrak{o} is an oval conic if and only if

for any six points $P_1, P_2, P_3, P_4, P_5, P_6 \in \mathfrak{o}$ points
 (P6) $P_7 := \overline{P_1P_5} \cap \overline{P_2P_4}, P_8 := \overline{P_1P_6} \cap \overline{P_3P_4}, P_9 := \overline{P_2P_6} \cap \overline{P_3P_5}$
 are collinear.

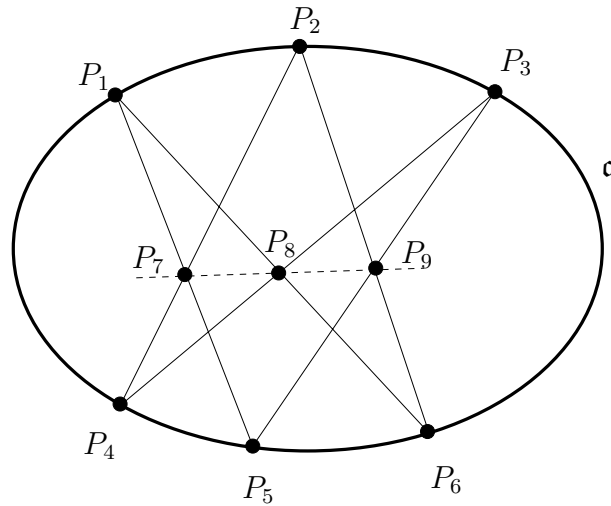

Figure 2.2: 6-point-PASCAL-theorem

Proof: Let \mathfrak{P} be inhomogeneously coordinatized by field K such that (in $\overline{\mathfrak{A}(K)}$) $P_1 = (\infty), P_6 = (0), P_i = (x_i, y_i)$ for $i = 2, 3, 4, 5, 7, 9$ and m_{ik} is the slope of line $\overline{P_iP_k}, i \neq k$.

The perspectivity (axial dilatation) with axis $x = x_5$ and center (0) which maps P_2 onto P_9 has the effect $m_{52} \rightarrow m_{59}, m_{72} \rightarrow m_{79}$. Hence: $\frac{m_{59}}{m_{52}} = \frac{m_{79}}{m_{72}}$. And from $m_{59} = m_{53}, m_{72} = m_{42}$ we get $m_{79} = m_{42} \cdot \frac{m_{53}}{m_{52}}$.

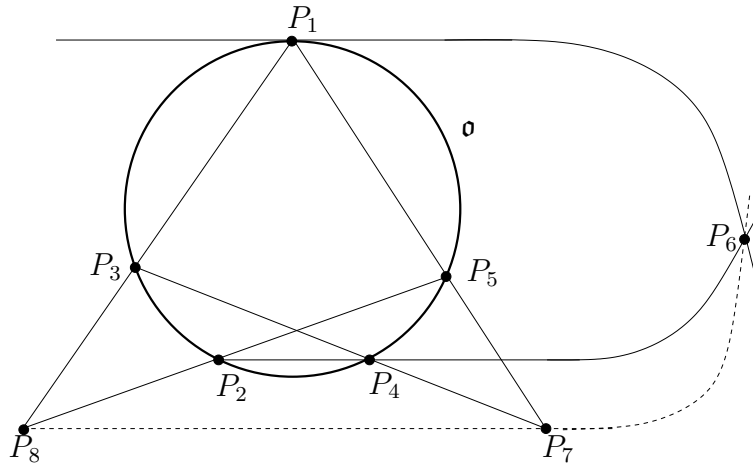

Figure 2.4: 5-point-PASCAL-theorem

shear (in $\mathfrak{A}(K)$) with axis $x = x_3$ which maps (m_{37}) onto (m_{35}) maps (m_{78}) onto (m_{58}) . Hence $m_{35} - m_{37} = m_{58} - m_{78}$. Because of $m_{34} = m_{37}$ and $m_{58} = m_{25}$ we get $m_{35} - m_{34} = m_{25} - m_{78}$.

I) Let be \mathfrak{o} a conic. Hence $\mathfrak{o} = \{(x, y) \in K^2 \mid y = ax^2 + bx + c\} \cup \{(\infty)\}$ for suitable

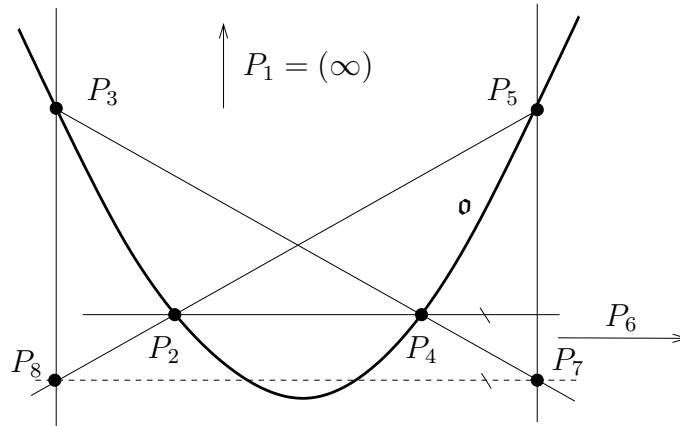

Figure 2.5: Proof to 5-point-PASCAL-theorem

$a, b, c \in K$. From Lemma 2.13 we get $m_{35} - m_{34} = m_{25} - m_{24}$ and $m_{78} = m_{24}$ which means: points P_6, P_7, P_8 are collinear.

II) Now we assume property (P5) for oval \mathfrak{o} . Hence $m_{24} = m_{78}$. From $m_{35} - m_{34} = m_{25} - m_{78}$ we get $m_{35} - m_{34} = m_{25} - m_{24}$. Lemma 2.13 yields $\mathfrak{o} = \{(x, y) \in K \mid y = ax^2 + bx + c\} \cup \{(\infty)\}$, $a \neq 0$ which means: \mathfrak{o} is an oval conic. \square

The importance of properties (P5) and (P6) for ovals in arbitrary projective planes shows the next result.

Result 2.15 (BUEKENHOUT/HOFMANN) *Let \mathfrak{o} be an oval of a projective plane \mathfrak{P} . The following statements are equivalent:*

- a) \mathfrak{P} is pappian and \mathfrak{o} an oval conic.
- b) (P6) is true for oval \mathfrak{o} . (BUEKENHOUT [BU'66])
- c) (P5) is true for oval \mathfrak{o} . (HOFMANN [HO'71])

For a pappian plane the degenerations (P4), (P3) ((P3) only in case of $\text{Char} \neq 2$) characterize oval conics, too. It is not clear if the assumption “pappian” can be omitted (see Result 2.15).

Theorem 2.16 (4-point-PASCAL) *Let \mathfrak{o} be an oval in a pappian projective plane \mathfrak{P} . \mathfrak{o} is an oval conic if and only if the following statement holds:*

- Let be $P_1, P_2, P_3, P_4 \in \mathfrak{o}$ any four points and $\overline{P_1P_1}, \overline{P_2P_2}$ the tangent lines at P_1 and P_2 to \mathfrak{o} . Then*
(P4) $P_5 := \overline{P_1P_1} \cap \overline{P_2P_2}$, $P_6 := \overline{P_1P_3} \cap \overline{P_2P_4}$, $P_7 := \overline{P_1P_4} \cap \overline{P_2P_3}$ are collinear.

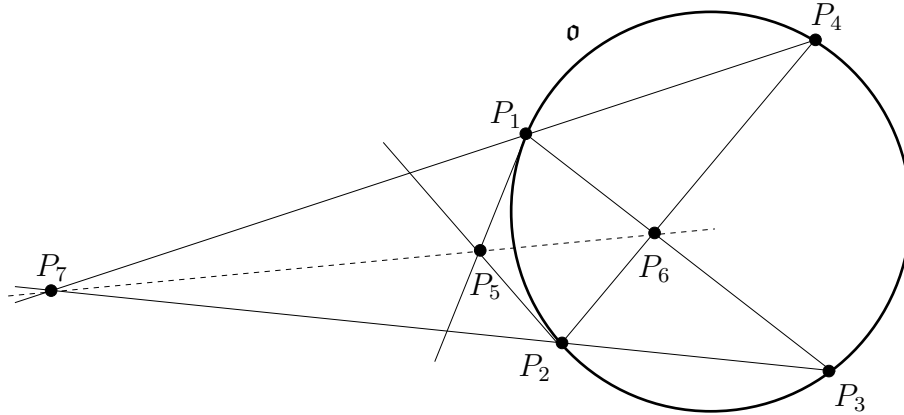

Figure 2.6: 4-point-PASCAL-theorem

Proof: We describe \mathfrak{P} as $\overline{\mathfrak{A}(K)}$ over a field K such that $P_1 = (0), P_2 = (\infty), P_3 = (1, 1), P_5 = (1, 1)$ and $P_i = (x_i, y_i)$ for $i = 4, 6, 7$.

I) In case “ \mathfrak{o} is conic” we have

$\mathfrak{o} = \{(x, y) \in K^2 \mid y = \frac{1}{x}, x \neq 0\} \cup \{(0), (\infty)\}$ and $P_7 = (1, x_4), P_6 = (x_4, 1)$. Obviously points P_5, P_6, P_7 are collinear.

II) Let \mathfrak{o} be an oval with property (P4). For \mathfrak{o} there exists a function f on $K \setminus \{0\}$ onto itself such that $\mathfrak{o} = \{(x, y) \in K^2 \mid y = f(x), x \neq 0\} \cup \{(0), (\infty)\}$. From the assumption “ P_5, P_6, P_7 are collinear” we get $P_7 = (1, f(x_4))$ and $P_6 = (x_4, 1)$. Because (P4) is true for *any* quadrilateral on \mathfrak{o} we find: $f(x) = \frac{1}{x}$ for all $x \in K \setminus \{0\}$. Hence \mathfrak{o} is an oval conic. \square

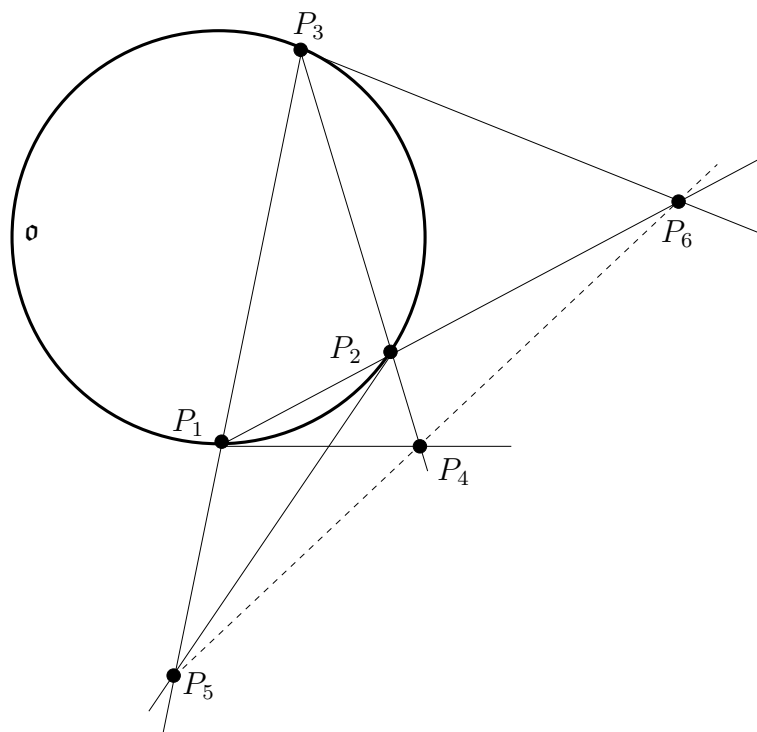

Figure 2.8: 3-point-PASCAL-theorem

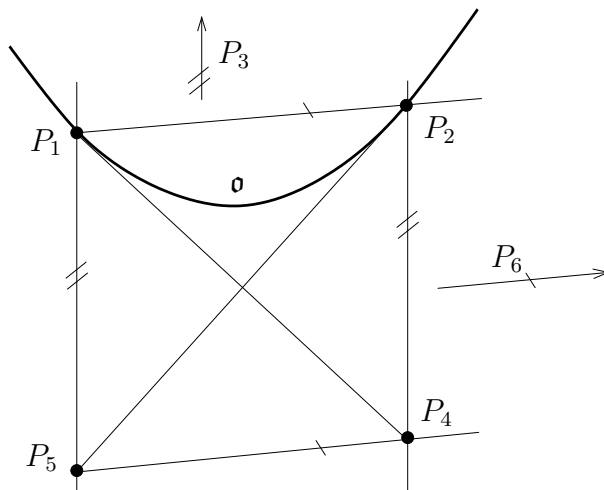

Figure 2.9: Proof to 3-point-PASCAL-theorem

$\mathfrak{o} = \{(x, y) \in K^2 \mid y = x^2, x \neq 0\} \cup \{(\infty)\}$ and $P_1 = (x_1, x_1^2), P_2 = (x_2, x_2^2)$ and the tangent line at P_i is $y = 2x_i(x - x_i) + x_i^2, i = 1, 2$ (see proof of Lemma 2.2). Hence $P_5 = (x_1, 2x_2(x_1 - x_2) + x_2^2)$ and $P_4 = (x_2, 2x_1(x_2 - x_1) + x_1^2)$. The slopes of lines $\overline{P_4P_5}$ and $\overline{P_1P_2}$ are both $x_1 + x_2$ which means: P_4, P_5, P_6 are collinear.

II) Let \mathfrak{o} be an oval with property (P3). For \mathfrak{o} there exists a function f on $K \setminus \{0\}$ onto

itself such that $\mathfrak{o} = \{(x, y) \in K^2 \mid y = f(x), x \neq 0\} \cup \{(\infty)\}$. The tangent line at $(x_0, f(x_0))$ has equation $y = f'(x_0)(x - x_0) + f(x_0)$. Hence: $P_5 = (x_1, f'(x_2)(x_1 - x_2) + f(x_2))$ and $P_4 = (x_2, f'(x_1)(x_2 - x_1) + f(x_1))$. Because of property (P3) the slopes of the lines $\overline{P_4, P_5}$ and $\overline{P_1, P_2}$ are equal and we get at first $f'(x_2) + f'(x_1) - \frac{f(x_2) - f(x_1)}{x_2 - x_1} = \frac{f(x_2) - f(x_1)}{x_2 - x_1}$ and herefrom the functional equation:

(i): $(f'(x_2) + f'(x_1))(x_2 - x_1) = 2(f(x_2) - f(x_1))$ for any $x_1, x_2 \in K$.

With $f(0) = f'(0) = 0$ we get (ii): $f'(x_2)x_2 = 2f(x_2)$ and $f(1) = 1$ yields (iii): $f'(1) = 2$. From (i) and (ii) follows (iv): $f'(x_2)x_1 = f'(x_1)x_2$ and, using (iii), we find (v): $f'(x_2) = 2x_2$ for any $x_2 \in K$. From (ii) and (v) we get $f(x_2) = x_2^2, x_2 \in K$ which means: \mathfrak{o} is an oval conic. \square

Theorem 2.18 (3-point-PASCAL, Char = 2) *An oval \mathfrak{o} in a pappian projective plane \mathfrak{P} of Char = 2 with a knot fulfills property (P3) from Theorem 2.17.*

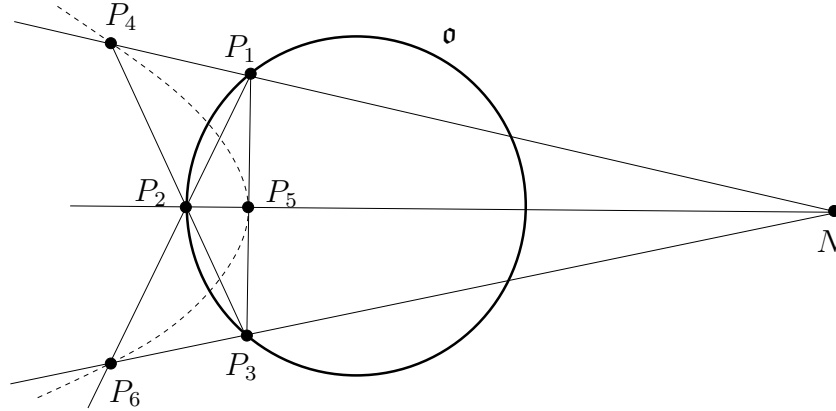

Figure 2.10: 3-point-PASCAL-theorem, Char = 2

Proof: Let be N the knot of oval \mathfrak{o} . Because of Char = 2 the intersection points of opposite sides of the quadrilateral P_1, P_2, P_3, N are collinear. That means: P_4, P_5, P_6 are collinear and (P3) is true. \square

Remark 2.4 a) *For a pappian projective plane of Char = 2 any oval conic has a knot and property (P3) is fulfilled.*

b) *For finite pappian planes of Char = 2 there exist ovals which are no oval conics (see Section 2.7.1). All these ovals have knots and hence property (P3).*

c) *For certain infinite pappian planes of Char = 2 there exist Moufang-ovals (see Section 2.7.2) which are not oval conics. Any of these ovals has a knot and hence property (P3).*

Conclusion: property (P3) is not typical for oval conics.

A property which is similar to (P3) is the following one.

Theorem 2.19 (perspective triangles) *Let \mathfrak{o} be an oval in a pappian projective plane \mathfrak{P} of $\text{Char} \neq 2$. \mathfrak{o} is an oval conic if and only if the following statement holds:*

Let be $P_1, P_2, P_3 \in \mathfrak{o}$ any three points and t_i the tangent line at P_i of \mathfrak{o} . Then

(PT) $Q_1 := t_2 \cap t_3$, $Q_2 := t_1 \cap t_3$, $Q_3 := t_1 \cap t_2$ are not collinear and the lines $\overline{P_i Q_i}$, $i = 1, 2, 3$ meet in a point.

(Triangles P_1, P_2, P_3 and Q_1, Q_2, Q_3 are perspective.)

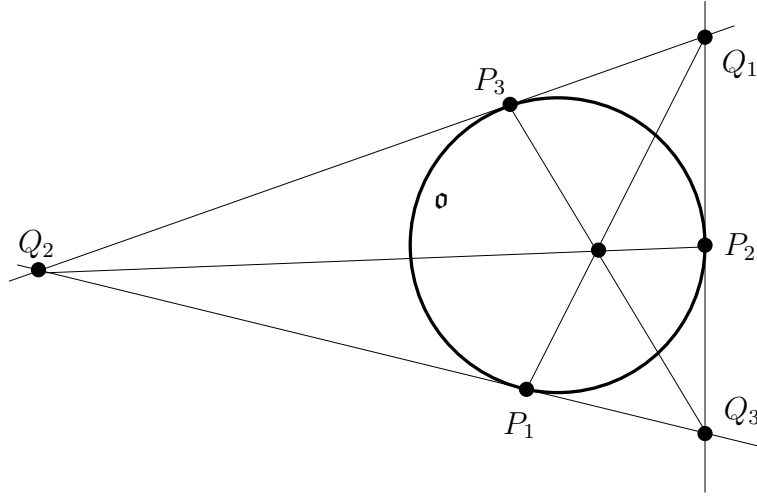

Figure 2.11: perspective triangles

Proof: We describe \mathfrak{P} as $\overline{\mathfrak{A}(K)}$ over a field K such that $P_3 = (\infty), t_1 = g_\infty$, $(0, 0), (1, 1) \in \mathfrak{o}$, x-axis is tangent line at $(0, 0)$ to \mathfrak{o} . Let be f a function on K such that: $\mathfrak{o} = \{(x, y) \in K^2 \mid y = f(x)\} \cup \{(\infty)\}$ and function f' represents the slopes of the tangents, i.e. $y = f'(x_0)(x - x_0) + f(x_0)$ is the tangent line at point $(x_0, f(x_0))$. With $P_1 = (x_1, f(x_1)), P_2 = (x_2, f(x_2))$ we get $Q_2 = (f'(x_1)), Q_1 = (f'(x_2))$ and with $Q_3 = (x_3, y_3)$ and $Z = (x_4, y_4) := \overline{P_2 Q_2} \cap \overline{P_1 Q_1}$ we get

$$(f'(x_1) - f'(x_2))x_3 = f(x_2) - f(x_1) + f'(x_1)x_1 - f'(x_2)x_2 \text{ and}$$

$$(f'(x_1) - f'(x_2))x_4 = f(x_1) - f(x_2) - f'(x_2)x_1 + f'(x_1)x_2.$$

I) For an oval conic we have $f(x) = x^2$ and $f'(x) = 2x$ (see proof of Lemma 2.2). One easily checks that $x_3 = x_4$ which means: $\overline{P_i Q_i}, i = 1, 2, 3$ meet at point Z .

II) Now let \mathfrak{o} have property (PT). Hence $x_3 = x_4$ and $(f'(x_2) + f'(x_1))(x_2 - x_1) = 2(f(x_2) - f(x_1))$ for $x_1, x_2 \in K$. This is the functional equation (i) from the proof to Theorem 2.17. Analogously we find $f(x) = x^2$ and \mathfrak{o} is an oval conic. \square

Remark 2.5 *If one assumes “Moufang–plane” (instead of pappian plane) in Theorem 2.18 and Theorem 2.19 the statements are true as well (Recognize: a commutative alternative division ring is a field!).*

An additional characterization of oval conics in case of $\text{Char} \neq 2$ by certain symmetries is due to MÄURER ([MÄ'76b],[MÄ'81] 4.2).

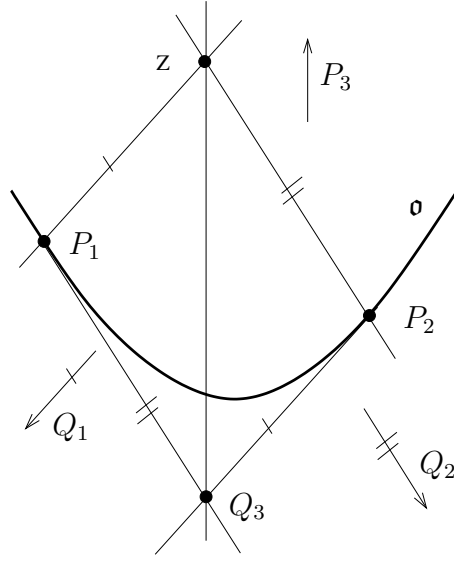

Figure 2.12: perspective triangles

Theorem 2.20 (MÄURER: \circ symmetric to tangent line) *Let \circ be an oval in a pappian projective plane \mathfrak{P} of $\text{Char} \neq 2$. \circ is an oval conic if and only if the following statement holds:*

(ST) \circ is symmetric (see Section 2.3) to every point $P \notin \circ$ on a tangent line.

Proof: I) In case of “ \circ is an oval conic” property (ST) follows from Theorem 2.9.

II) Let \circ be an oval, U a point on \circ , u the tangent line at U to \circ and let \circ be symmetric to every point $P \in u \setminus \circ$. We describe \mathfrak{P} as $\overline{\mathfrak{A}(K)}$ over a field K such that $U = (\infty)$, $u = g_\infty$, $(1, 1), (0, 0) \in \circ$ and $y = 0$ is the tangent line at $(0, 0)$. There exists a function f of K into itself such that $\circ = \{(x, y) \in K^2 \mid y = f(x)\} \cup \{(\infty)\}$. We assign the slope of the tangent line at $(x_0, f(x_0))$ by $f'(x_0)$. The symmetry σ_0 at point $(f'(x_0)) \in g_\infty$ which leaves \circ invariant has line $x = x_0$ as axis and has on K^2 the representation $(x, y) \rightarrow (-x + 2x_0, y - 2f'(x_0)(x - x_0))$. From the invariance of \circ by application of σ_0 we get the following functional equation for f and f' :

$$f(x) - 2f'(x_0)(x - x_0) = f(-x + 2x_0) \text{ for } x, x_0 \in K.$$

With $x_1 := x - x_0$ we find $(*) f(x_0 + x_1) - f(x_0 - x_1) = 2f'(x_0)x_1$ for any $x_0, x_1 \in K$. For $x_1 = 0$ we get $f(x) = f(-x), x \in K$. Hence the left side of $(*)$ is invariant while exchanging x_0 and x_1 . Applying this symmetry onto the right side we get: $f'(x_0)x_1 = f'(x_1)x_0$ and $x_1 = 1$ yields $f'(x_0) = f'(1)x_0$ for $x_0 \in K$. From $(*)$ for $x_0 = x_1$ we get $f(2x_0) = 2f'(1)x_0^2$. With $f(1) = 1$ it follows: $f(x) = x^2, x \in K$, which means that \circ is an oval conic. \square

Remark 2.6 *Theorem 2.20 can not be extended to $\text{Char} = 2$ (see Section 2.7.1).*

We cite a similar result due to MÄURER ([MÄ'76b], [MÄ'81] 4.3), too, which is much more difficult to prove.

II) Let π be a perspectivity from $B(U)$ onto $B(V)$. Because both π and $\pi_2\pi_1$ have the same effect on the lines $x = 0, g_\infty$ and $x = 1$ we get from Result 1.17 e) that $\pi = \pi_2\pi_1$. Hence points $(0, 0), (x_0, 1), (1, f(x_0))$ are collinear for any $x_0 \in K \setminus \{0\}$ and therefore $f(x_0) = \frac{1}{x_0}$ which means: \mathfrak{o} is an oval conic. \square

Remark 2.7 *The second classical definition of a conic is due to v. STAUDT which uses the term “polarity” (see LENZ [LE’65]). Because the definition via a polarity yields only an oval in case of Char $\neq 2$ (see BERZ [BZ’62]) we omit it here.*

2.5 Oval conics in affine planes

Let be \mathfrak{P} be a pappian projective plane and $\mathfrak{P}(K)$ the homogeneous model of \mathfrak{P} over a field K (see Section 1.2.4) and let be \mathfrak{c} the oval conic in $\mathfrak{P}(K)$ with equation $x_1^2 = x_2x_3$ (see Section 2.3). We shall discuss the question when there is a line g_∞ such that $\mathfrak{c} \cap g_\infty = \emptyset$. Hence \mathfrak{c} is an oval in the affine plane with g_∞ as line at infinity.

Let be g_∞ a line of $\mathfrak{P}(K)$ with equation $ax_1 + bx_2 + cx_3 = 0$ and $\mathfrak{c} \cap g_\infty = \emptyset$. From $\langle (0, 1, 0) \rangle, \langle (0, 0, 1) \rangle \in \mathfrak{c}$ we get $b \neq 0, c \neq 0$ and the equation $ax_1x_2 + bx_2^2 + cx_1^2 = 0$ has only the solution $(0, 0, 0)$ which means: polynomial $c\xi^2 + a\xi + b$ is irreducible over K . (The reverse is also true: If $c\xi^2 + a\xi + b$ is irreducible over K then line g_∞ with equation $ax_1 + bx_2 + cx_3 = 0$ and oval \mathfrak{c} have no points in common.) We set $c = 1$ and perform the coordinate transformation $x'_1 = x_1, x'_2 = x_2, x'_3 = ax_1 + bx_2 + x_3$. Hence g_∞ has equation $x'_3 = 0$ and conic \mathfrak{c} the equation $x_1'^2 + ax'_1x'_2 + bx_2'^2 - x'_2x'_3 = 0$. After introducing inhomogeneous coordinates with $x = \frac{x'_1}{x'_3}, y = \frac{x'_2}{x'_3}$ equation $x^2 + axy + by^2 - y = 0$ describes an oval in $\mathfrak{A}(K)$. This proves the following theorem.

Theorem 2.23 (oval conic in $\mathfrak{A}(K)$) *Let be K a field.*

The point set $\mathfrak{o} = \{(x, y) \mid x^2 + axy + by^2 - y = 0\}$ for $a, b \in K$ is an oval in the affine plane $\mathfrak{A}(K)$ if and only if polynomial $\xi^2 + a\xi + b$ is irreducible over K .

From Theorem 2.23 and a suitable coordinate transformation for $\mathfrak{A}(K)$ we get the following special results.

Theorem 2.24 (special affine oval conics) *Let be K a field.*

- a) *The point set $\mathfrak{o} = \{(x, y) \mid x^2 + axy + y^2 = 1\}$ for $a \in K$ is an oval in the affine plane $\mathfrak{A}(K)$ if and only if polynomial $\xi^2 + a\xi + 1$ is irreducible over K .*
- b) *In case of Char = 2 point set $\mathfrak{o} = \{(x, y) \mid x^2 + by^2 + y = 0\}$ for $b \in K$ is an oval in the affine plane $\mathfrak{A}(K)$ if and only if b is no square. The tangent lines of \mathfrak{o} are parallel to the x -axis, i.e. the knot of \mathfrak{o} in $\overline{\mathfrak{A}(K)}$ is point (0) .*

Remark 2.8 a) *For $K = GF(2)$ polynomial $\xi^2 + \xi + 1$ is irreducible.*

- b) *For $K = GF(q)$ number -1 is no square if and only if $q \equiv 3 \pmod{4}$. Hence equation $x^2 + y^2 = 1$ describes an oval in $\mathfrak{A}(GF(q))$ if and only if $q \equiv 3 \pmod{4}$.*

- c) For $K = \mathbf{Q}$ polynom $\xi^2 - 2$ (for example) is irreducible. Hence equation $x^2 - 2y^2 = 1$ describes an oval in $\mathfrak{A}(\mathbf{Q})$ (but not in $\mathfrak{A}(\mathbf{R})$!).

2.6 Finite ovals

Here we collect some properties typical for finite ovals.

Theorem 2.25 (set of $n + 1$ points) *Let be \mathfrak{P} a projective plane of order n . A set \mathfrak{o} of points is an oval if $|\mathfrak{o}| = n + 1$ and if no three points of \mathfrak{o} are collinear.*

Proof: I) If \mathfrak{o} is an oval no three points are collinear (see definition of an oval). Because for any point $P \in \mathfrak{o}$ there is exactly one tangent line we have n secant lines through point P which meet \mathfrak{o} in exactly one additional point. Hence $|\mathfrak{o}| = n + 1$.

II) Let be \mathfrak{o} a set of $n + 1$ points with “no three collinear”. For any point $P \in \mathfrak{o}$ there are exactly n lines through P which have exactly one additional point with \mathfrak{o} in common. Hence there is exactly one line t_P through P with $|t_P \cap \mathfrak{o}| = 1$ and \mathfrak{o} is an oval. \square

Theorem 2.26 (QVIST [QV’52]) *Let be \mathfrak{P} a projective plane of order n and \mathfrak{o} an oval in \mathfrak{P} .*

- a) *If n is odd any point $P \notin \mathfrak{o}$ lies on 0 or 2 tangent lines.*
 b) *In case of “ n is even” oval \mathfrak{o} has a complete knot, i.e. there exists a point N which lies on all tangent lines of oval \mathfrak{o} and any line through N is a tangent line.*

Proof: a) Let be $P_0 \in \mathfrak{o}$, t_0 the tangent line at P_0 and $t_0 = \{P_0, P_1, \dots, P_n\}$. The lines

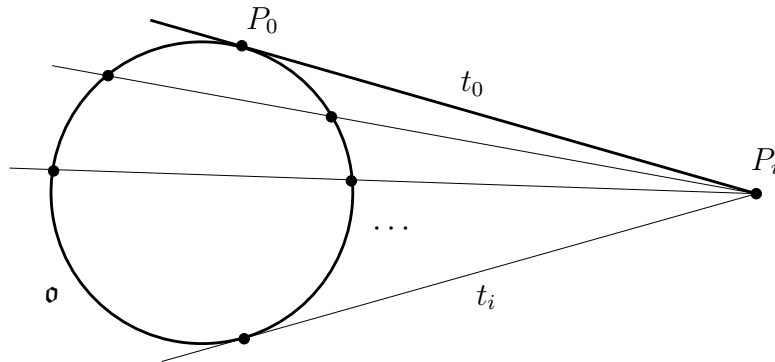

Figure 2.14: To proof of theorem of QVIST, n odd

through $P_i, i \neq 0$ dissect oval \mathfrak{o} into subsets of order 2 or 1 or 0. Because “ $|\mathfrak{o}| = n + 1$ is even” for any point $P_i, i \neq 0$ there is an additional tangent line t_i . The number of tangent lines is $n + 1$. Hence through any point $P_i, i \neq 0$ there are exactly two tangents: t_0 and t_i .

b) Let be s a secant line, $s \cap \mathfrak{o} = \{P_0, P_1\}$ and $s = \{P_0, P_1, \dots, P_n\}$. Because $|\mathfrak{o}| = n + 1$ is odd for any point $P_i, i = 2, \dots, n$ there exists at least one tangent line t_i . The total

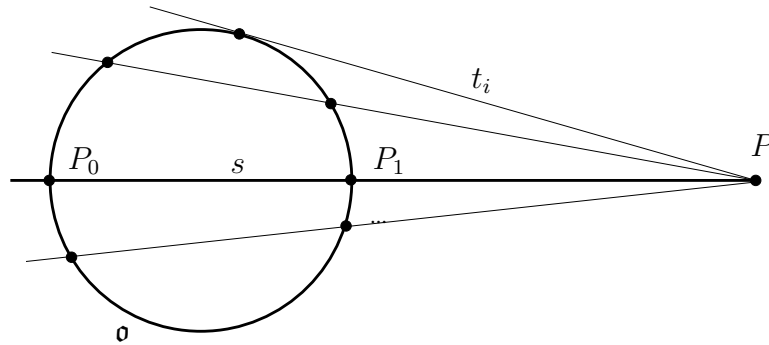

Figure 2.15: To proof of theorem of QVIST, n even

number of tangents is $n + 1$. Hence any point P_i lies on exactly one tangent line. Let be N the intersection point of a pair of tangents. No line through N can be an exterior line. $|\mathfrak{o}| = n + 1$ shows: any line through N is a tangent line. \square

For *pappian* projective planes of odd order all ovals were determined by SEGRE [SE'55]. Here we give a slight different proof.

Theorem 2.27 (SEGRE: ovals in pappian planes of odd order) *Let be \mathfrak{P} a pappian projective plane of odd order. Any oval in \mathfrak{P} is an oval conic.*

Proof:

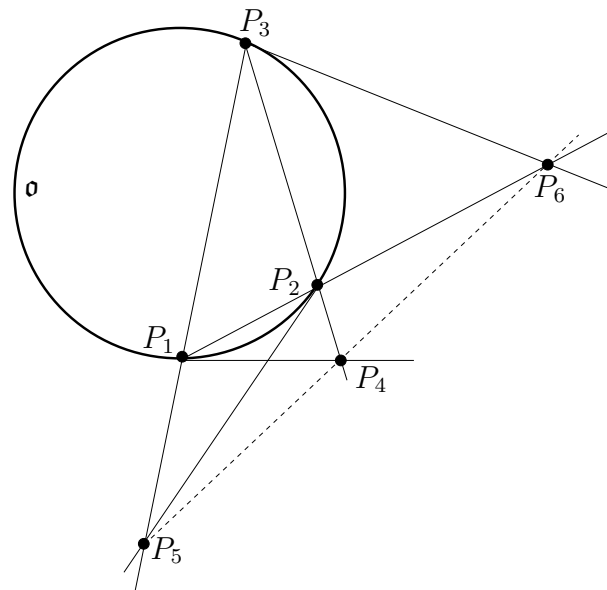

Figure 2.16: Proof of theorem of Segre: 3-point-PASCAL-theorem

We show that any oval \mathfrak{o} in a pappian plane \mathfrak{P} of odd order has property (P_3) of Theorem 2.17.

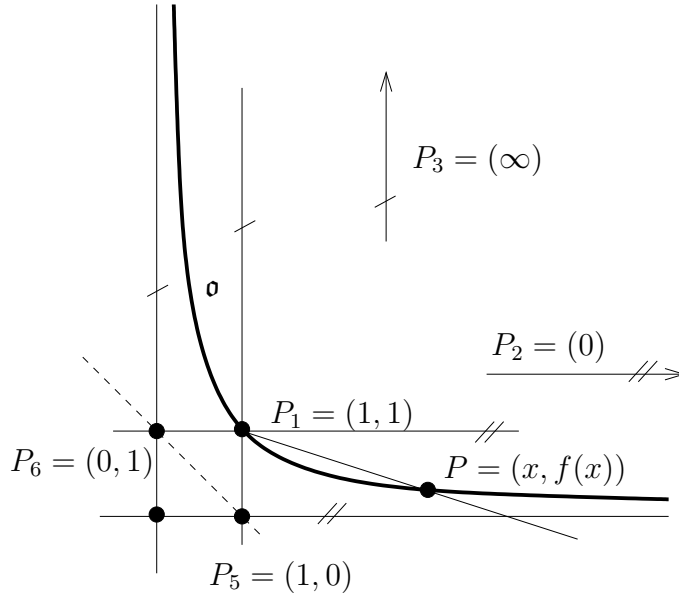

Figure 2.17: Proof of theorem of SEGRE: \mathfrak{o} coordinatized inhomogeneously

Let be P_1, P_2, P_3 an arbitrary triangle on \mathfrak{o} and P_4, P_5, P_6 defined as in Theorem 2.17. We describe \mathfrak{P} as $\overline{\mathfrak{A}(K)}$ over $K = GF(n)$ such that $P_3 = (\infty), P_2 = (0), P_1 = (1, 1)$ and $(0, 0)$ is the intersection point of the tangent lines at P_2 and P_3 . Hence $P_5 = (1, 0)$ and $P_6 = (0, 1)$. Oval \mathfrak{o} can be described by a bijective function f from $K \setminus \{0\}$ onto itself: $\mathfrak{o} = \{(x, y) \in K^2 \mid y = f(x), x \neq 0\} \cup \{(0), (\infty)\}$.

For point $P = (x, f(x)), x \in K \setminus \{0, 1\}$ the slope of the line $\overline{PP_1}$ is $m(x) = \frac{f(x)-1}{x-1}$. Both mappings $x \rightarrow f(x) - 1$ and $x \rightarrow x - 1$ are bijections from $K \setminus \{0, 1\}$ onto $K \setminus \{0, -1\}$ and hence $x \rightarrow m(x)$ is a bijection from $K \setminus \{0, 1\}$ onto $K \setminus \{0, m_1\}$ where m_1 is the slope of the tangent line at P_1 . With the abbreviation $K^{**} := K \setminus \{0, 1\}$ we get:

$$\prod_{x \in K^{**}} (f(x) - 1) = \prod_{x \in K^{**}} (x - 1) = 1 \quad \text{and} \quad m_1 \cdot \prod_{x \in K^{**}} \frac{f(x) - 1}{x - 1} = -1.$$

(Recognize: For $K^* := K \setminus \{0\}$ we have: $\prod_{x \in K^*} k = -1$.) Hence

$$-1 = m_1 \cdot \prod_{x \in K^{**}} \frac{f(x) - 1}{x - 1} = m_1 \cdot \frac{\prod_{x \in K^{**}} (f(x) - 1)}{\prod_{x \in K^{**}} (x - 1)} = m_1.$$

Because both the slopes of $\overline{P_5P_6}$ and tangent $\overline{P_1P_1}$ are -1 we get $\overline{P_1P_1} \cap \overline{P_2P_3} = P_4 \in \overline{P_5P_6}$. This is true for any triangle $P_1, P_2, P_3 \in \mathfrak{o}$. Theorem 2.17 proves: \mathfrak{o} is an oval conic. \square

Additional finite ovals are contained in Section 2.7 especially ovals in desarguesian planes of even order which are no oval conics.

2.7 Further examples of ovals

2.7.1 Translation-ovals

Definition 2.7 Let be \mathfrak{P} a projective plane, \mathfrak{o} an oval in \mathfrak{P} , t a tangent line of \mathfrak{o} and $E(\mathfrak{o}, t)$ the set of elations with axis t which leave \mathfrak{o} invariant. \mathfrak{o} is called **translation-oval** if the following property holds:

(TO) There is a tangent line t_0 of \mathfrak{o} such that $E(\mathfrak{o}, t_0)$ operates transitively on $\mathfrak{o} \setminus t_0$.

It follows directly from the definition:

Lemma 2.28 Any translation-oval has a knot.

Example 2.3 a) The simplest examples are oval conics in a pappian plane of $\text{Char} = 2$:

For a field K with $\text{Char}K = 2$ the point set

$\mathfrak{o} := \{(x, y) \mid y = x^2\} \cup \{(\infty)\}$ in $\overline{\mathfrak{A}(K)}$ is a translation-oval. The set $E(\mathfrak{o}, g_\infty)$ of elations are translations in $\mathfrak{A}(K)$ of the following form: $(x, y) \rightarrow (x + x_0, y + x_0^2)$, $x_0 \in K$ and operates transitively on $\mathfrak{o} \setminus t_0$.

b) If one exchanges the knot of an oval from examples a) with an arbitrary point of \mathfrak{o} one gets a further translation-oval:

For a field K with $\text{Char}K = 2$ the point set

$\mathfrak{o} := \{(x, y) \mid y = x^2\} \cup \{(0)\}$ in $\overline{\mathfrak{A}(K)}$ is a translation-oval (see Theorem 2.3).

c) Let be $K = GF(2^n)$ and

$\mathfrak{o}(k) := \{(x, y) \mid y = x^{2^k}\} \cup \{(\infty)\}$ where $k \in \{1, \dots, n-1\}$ and k and n have no common divisor. Then: \mathfrak{o} is a translation-oval in $\overline{\mathfrak{A}(K)}$. (see SEGRE [SE'57], DEMBOWSKI [DE'68], p. 51).

The importance of examples c) shows the following result.

Result 2.29 (PAYNE [PA'71]) Any translation-oval in a desarguesian plane $\overline{\mathfrak{A}(K)}$ over a field $K = GF(2^n)$ is equivalent to an oval $\mathfrak{o}(k)$ of examples c) above.

Remark 2.9 Until now (1984) examples c) above are the only ovals known in $\overline{\mathfrak{A}(K)}$ for $GF(2^n)$.

Further examples of translation-ovals are contained in the following section.

2.7.2 Moufang–ovals

Definition 2.8 Let be \mathfrak{P} a projective plane, \mathfrak{o} an oval in \mathfrak{P} , t a tangent line of \mathfrak{o} and $E(\mathfrak{o}, t)$ the set of elations with axis t which leave \mathfrak{o} invariant. \mathfrak{o} is called **Moufang–oval** if the following property holds.

(MO) There are two tangent lines t_1, t_2 of \mathfrak{o} such that $E(\mathfrak{o}, t_1)$ and $E(\mathfrak{o}, t_2)$ operate transitively on $\mathfrak{o} \setminus t_1$ and $\mathfrak{o} \setminus t_2$ respectively.

From the definition we recognize: any Moufang–oval is a translation–oval and the statements in the following lemma are true.

Lemma 2.30 a) Any Moufang–oval has a knot.

b) Let \mathfrak{o} be a Moufang–oval and t an arbitrary tangent line of \mathfrak{o} . Then the set $E(\mathfrak{o}, t)$ of elations operates transitively on $\mathfrak{o} \setminus t$.

The following result is a construction tool for Moufang–ovals.

Result 2.31 (HARTMANN [HA’81c]) Let K be a skewfield and f an injective function from K into itself with $f(0) = 0, f(1) = 1$.

$\mathfrak{o} = \{(x, y) \in K^2 \mid y = f(x)\} \cup \{(\infty)\}$ is a Moufang–oval in $\overline{\mathfrak{A}(K)}$ if and only if

(i) $f(x_1 + x_2) = f(x_1) + f(x_2), x_1, x_2 \in K,$ (ii) $f(xf(x)^{-1}) = f(x)^{-1}, x \in K \setminus \{0\}.$

Example 2.4 Due to result 2.31 one has to find suitable skewfields and functions with properties (i), (ii).

a) Let be K_0 a field with $\text{Char}K = 2$ and $K := K_0(t)$ a transcendental expansion of K_0 . Then $L := K_0(t^2)$ is a subfield of K and any $x \in K$ can be written as $x = \xi + \eta t$ with $\xi, \eta \in L$. Furthermore $L^2 := \{x^2 \mid x \in L\}$ is a subfield of L . Hence L is a vector space over L^2 . For any element $\alpha \in L \setminus L^2$ function $f : \xi + \eta t \rightarrow \xi^2 + \alpha \eta^2$ fulfills conditions (i) and (ii) of Result 2.31 (see TITS [TI’62] 2.4.). (For $\alpha = t^2$ we get $f(x) = x^2$ and \mathfrak{o} is an oval conic.)

b) Let be K_0 a field with $\text{Char}K = 2$ and there exists an involutorial automorphism σ of K_0 . $K := K(t; \sigma)$ is the skewfield with $kt = tk^\sigma, k \in K_0$ (see COHN [CO’77], p.441). Then $L = K_0(t^2)$ is a commutative subskewfield of K . Any element of K can be written as $\xi + t\eta, \xi, \eta \in L$. Function $f : \xi + t\eta \rightarrow \xi^2 + t^2\eta^2$ fulfills conditions (i) and (ii) of Result 2.31 (see HARTMANN [HA’81c]).

c) HARTMANN [HA’81c] contains Moufang–ovals in non desarguesian Moufang planes, too.

For finite Moufang–ovals we have:

Result 2.32 (TITS [TI’62]) Any Moufang–oval of a **finite** desarguesian plane is an oval conic. (see also [HA’81c])

2.7.3 Ovals in Moulton–planes

Let be K an euclidean field, i.e. K is ordered and any positive element is a square, and $k \in K, k > 0$. We define on K a new multiplication \circ :

$$a \circ b := \begin{cases} kab & , a, b < 0 \\ ab & , \text{ other cases} \end{cases}$$

Hence $\mathfrak{P} := (\mathcal{P}, \mathcal{G}, \in)$ with

$$\begin{aligned} \mathcal{P} &:= K^2 \cup K \cup \{\infty\}, \quad \infty \notin K, \\ \mathcal{G} &= \{(x, y) \in K^2 \mid y = m \circ x + b\} \cup \{(m)\} \mid m, b \in K\} \\ &\quad \cup \{(x, y) \in \mathcal{P} \mid x = c\} \cup \{(\infty)\} \mid c \in K\} \\ &\quad \cup \{(m) \mid m \in K \cup \{(\infty)\}\}. \end{aligned}$$

is a projective Moulton–plane and

$\mathfrak{o} := \{(x, y) \mid y = x \circ x\} \cup \{(\infty)\}$ is an oval in \mathfrak{P} (see [HA'76]).

2.7.4 Ovals in planes over nearfields

Let be $(K, +, \cdot, f)$ a planar Tits–nearfield (see Section 7.5). Then $\mathfrak{P} := (\mathcal{P}, \mathcal{G}, \in)$ with

$$\begin{aligned} \mathcal{P} &:= K^2 \cup K \cup \{\infty\}, \quad \infty \notin K, \\ \mathcal{G} &= \{(x, y) \in K^2 \mid y = mx + b\} \cup \{(m)\} \mid m, b \in K\} \\ &\quad \cup \{(x, y) \in \mathcal{P} \mid x = c\} \cup \{(c)\} \mid c \in K\} \\ &\quad \cup \{(m) \mid m \in K \cup \{(\infty)\}\}. \end{aligned}$$

is a projective plane and

$\mathfrak{o} := \{(x, y) \mid y = f(x), x \neq 0\} \cup \{(0), (\infty)\}$ is an oval in \mathfrak{P} (see Section 6.3).

2.7.5 Ovals in finite planes over quasifields

Let be $K = GL(p^n)$ with $p > 2$ and $n \geq 1$. We define a new multiplication \circ :

$$a \circ b := \begin{cases} ab & , a \text{ is a square} \\ ab^p & , a \text{ is no square} \end{cases}$$

Then $(K, +, \circ)$ is an ANDRÉ–quasifield (see [HU,PI'73], p. 187) and $\mathfrak{P} = (\mathcal{P}, \mathcal{G}, \in)$ with

$$\begin{aligned} \mathcal{P} &:= K^2 \cup K \cup \{\infty\}, \quad \infty \notin K, \\ \mathcal{G} &= \{(x, y) \in K^2 \mid y = m \circ x + b\} \cup \{(m)\} \mid m, b \in K\} \\ &\quad \cup \{(x, y) \in \mathcal{P} \mid x = c\} \cup \{(\infty)\} \mid c \in K\} \\ &\quad \cup \{(m) \mid m \in K \cup \{(\infty)\}\}. \end{aligned}$$

is a projective plane and

$\mathfrak{o} := \{(x, y) \mid y = \frac{1}{x}, x \neq 0\} \cup \{(0), (\infty)\}$ ($\frac{1}{x}$ is the inverse of x with respect of the field multiplication) is an oval in \mathfrak{P} .

Remark 2.10 a) For $n = 1$ we have $(K, +, \circ) = (K, +, \cdot)$ and \mathfrak{o} is an oval conic.

- b) For $n = 2$ $(K, +, \circ)$ is a Tits–nearfield and \mathfrak{o} an example given in Section 2.7.4.
 c) For $n \geq 3$ $(K, +, \circ)$ is a non associative quasifield.

2.7.6 Real ovals on convex functions

Let be $f : \mathbb{R} \rightarrow \mathbb{R}$ a convex function (see [RO,VA'73]) with properties

- (i) f is differentiable,
 (ii) f' is a strongly monotone increasing bijection of \mathbb{R} .

Then $\mathfrak{o} := \{(x, y) \mid y = f(x)\} \cup \{(\infty)\}$ is an oval in $\overline{\mathfrak{A}(\mathbb{R})}$ (see [HA'84]).

Chapter 3

MOEBIUS–PLANES

Literature: [BE'73], [BP'83], [DE'68], [EW'71]

3.1 The classical real Moebius–plane

We start from the euclidean plane. \mathbb{R}^2 is the point set, the lines are described by equations $y = mx + b$ or $x = c$ and a circle is a set of points which fulfills an equation $(x - x_0)^2 + (y - y_0)^2 = r^2$, $r > 0$. The geometry of lines and circles of the euclidean plane can be homogenized (similar to the projective completion of an affine plane) by embedding into the incidence structure $(\mathcal{P}, \mathcal{Z}, \in)$ with

$\mathcal{P} := \mathbb{R}^2 \cup \{\infty\}$, $\infty \notin \mathbb{R}$, the set of points, and

$\mathcal{Z} := \{g \cup \{\infty\} \mid g \text{ line of } \mathfrak{A}(\mathbb{R})\} \cup \{k \mid k \text{ circle of } \mathfrak{A}(\mathbb{R})\}$ the set of cycles.

$(\mathcal{P}, \mathcal{Z}, \in)$ is called **classical real Moebius–plane**. Within the new structure the completed lines play no special role anymore. Obviously $(\mathcal{P}, \mathcal{Z}, \in)$ has the following properties.

Lemma 3.1 a) For any set of three points A, B, C there is exactly one cycle z which contains A, B, C .

b) For any cycle z , any point $P \in z$ and $Q \notin z$ there exists exactly one cycle z' with: $P, Q \in z'$ and $z \cap z' = \{P\}$, i.e. z and z' touch each other at point P .

The automorphisms of geometry $(\mathcal{P}, \mathcal{Z}, \in)$ can be described easily using the complex plane (complex number $z = x + iy$ is represented by point $(x, y) \in \mathbb{R}^2$):

$\mathcal{P} := \mathbb{C} \cup \{\infty\}$, $\infty \notin \mathbb{C}$, and

$\mathcal{Z} := \{\{z \in \mathbb{C} \mid az + \overline{a}z + b = 0\} \cup \{\infty\} \mid 0 \neq a \in \mathbb{C}, b \in \mathbb{R}\}$
 $\cup \{\{z \in \mathbb{C} \mid (z - z_0)(\overline{z - z_0}) = d \mid z_0 \in \mathbb{C}, d \in \mathbb{R}, d > 0\}$

($\overline{z} = x - iy$ is the conjugate number of z .)

One easily checks that the following permutations of \mathcal{P} are automorphisms of $(\mathcal{P}, \mathcal{Z}, \in)$.

$$\begin{aligned}
 (1) \quad & \begin{cases} z & \rightarrow rz \\ \infty & \rightarrow \infty \end{cases} && \text{with } r \in \mathbb{C} && \text{(rotation + dilatation)} \\
 (2) \quad & \begin{cases} z & \rightarrow z + s \\ \infty & \rightarrow \infty \end{cases} && \text{with } s \in \mathbb{C} && \text{(translation)} \\
 (3) \quad & \begin{cases} z & \rightarrow \frac{1}{z}, z \neq 0 \\ 0 & \rightarrow \infty \\ \infty & \rightarrow 0 \end{cases} && \text{with } s \in \mathbb{C} && \text{(reflection at } \pm 1) \\
 (4) \quad & \begin{cases} z & \rightarrow \bar{z} \\ \infty & \rightarrow \infty \end{cases} && && \text{(reflection at x-axis)}
 \end{aligned}$$

Considering $\mathbb{C} \cup \{\infty\}$ as projective line over \mathbb{C} one recognizes that the mappings (1) – (3) generate the group $PGL(2, \mathbb{C})$. We shall see (result 3.10) that (1) – (4) already generate the full automorphism group of $(\mathcal{P}, \mathcal{Z}, \in)$. Hence the automorphism group operates 3-transitively on the point set \mathcal{P} and transitively on the set \mathcal{Z} of cycles. The geometry $(\mathcal{P}, \mathcal{Z}, \in)$ is a rather homogeneous structure.

Similar to the space model of a desarguesian projective plane there exists a space model for the geometry $(\mathcal{P}, \mathcal{Z}, \in)$ which omits the formal difference between cycles defined by lines and cycles defined by circles: The geometry $(\mathcal{P}, \mathcal{Z}, \in)$ is isomorphic to the geometry of circles on a sphere. The isomorphism can be performed by a suitable *stereographic projection* (see Section 3.3.7).

3.2 The axioms of a Moebius-plane

The incidental behavior of the classical real Moebius-plane (Lemma 3.1) gives reason to the following definition of an axiomatic Moebius-plane.

Definition 3.1 *An incidence structure $\mathfrak{M} = (\mathcal{P}, \mathcal{Z}, \in)$ with point set \mathcal{P} and set of cycles \mathcal{Z} is called **Moebius-plane** if the following axioms hold:*

A1: For any three points A, B, C there is exactly one cycle z which contains A, B, C .

A2: For any cycle z , any point $P \in z$ and $Q \notin z$ there exists exactly one cycle z' with: $P, Q \in z'$ and $z \cap z' = \{P\}$ (z and z' touch each other at point P).

A3: Any cycle contains at least three points. There is at least one cycle.

Four points A, B, C, D are concyclic if there is a cycle z with $A, B, C, D \in z$.

One should not expect that the axioms above define the classical real Moebius plane. There are a lot of examples of axiomatic Moebius planes which are different from the classical one. Similar to the minimal model of an affine plane one find the **minimal model** of a Moebius-plane. It consists of 5 points:

$$\mathcal{P} := \{A, B, C, D, \infty\}, \quad \mathcal{Z} := \{z \mid z \subset \mathcal{P}, |z| = 3\}. \quad \text{Hence: } |\mathcal{Z}| = \binom{5}{3} = 10.$$

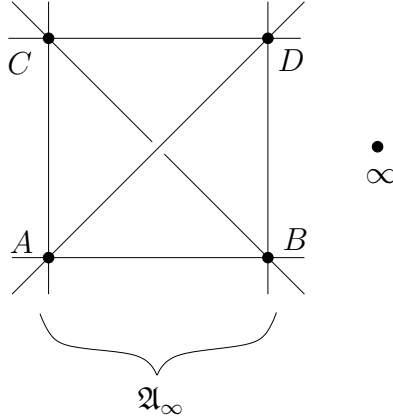

Figure 3.1: Minimal model of a Moebius-plane

The connection between the classical Moebius-plane and the real affine plane can be found in a similar way between the minimal model of a Moebius-plane and the minimal model of an affine plane. This strong connection is typical for Moebius-planes and affine planes (see below).

Definition 3.2 For a Moebius-plane $\mathfrak{M} = (\mathcal{P}, \mathcal{Z}, \in)$ and $P \in \mathcal{P}$ we define structure

$$\mathfrak{A}_P := (\mathcal{P} \setminus \{P\}, \{z \setminus \{P\} \mid P \in z \in \mathcal{Z}\}, \in)$$

and call it the **residue at point P**.

The essential meaning of the residue shows the following theorem.

Theorem 3.2 Any residue of a Moebius-plane is an affine plane.

The proof is a direct consequence of the axioms A1–A3.

Theorem 3.2 allows to use the plenty results on affine planes for investigations on Moebius-planes and gives rise to an equivalent definition of a Moebius-plane:

Theorem 3.3 An incidence structure $(\mathcal{P}, \mathcal{Z}, \in)$ is a Moebius-plane if and only if the following property is fulfilled

(A') For any point $P \in \mathcal{P}$ the residue $\mathfrak{A}_P := (\mathcal{P} \setminus \{P\}, \{z \setminus \{P\} \mid P \in z \in \mathcal{Z}\}, \in)$ is an affine plane.

For the classical real Moebius-plane any cycle which does not contain point ∞ is an oval conic (circle) in the residue \mathfrak{A}_∞ . In general the following is true.

Theorem 3.4 *Let be $\mathfrak{M} = (\mathcal{P}, \mathcal{Z}, \in)$ a Moebius-plane, \mathfrak{A}_P a residue and z a cycle with $P \notin z$. Then: cycle z is an oval in the affine plane \mathfrak{A}_P .*

The proof is a direct consequence of axioms A1–A3, too.

For finite Moebius-planes, i.e. $|\mathcal{P}| < \infty$, we have (similar to affine planes):

Lemma 3.5 *Any two cycles of a Moebius-plane have the same number of points.*

This gives reason for the following definition.

Definition 3.3 *For a finite Moebius-plane $\mathfrak{M} = (\mathcal{P}, \mathcal{Z}, \in)$ and a cycle $z \in \mathcal{Z}$ the integer $n := |z| - 1$ is called **order** of \mathfrak{M} .*

From combinatorics we get

Lemma 3.6 *Let $\mathfrak{M} = (\mathcal{P}, \mathcal{Z}, \in)$ be a Moebius-plane of order n . Then*

- a) *any residue \mathfrak{A}_P is an affine plane of order n ,*
- b) $|\mathcal{P}| = n^2 + 1,$ c) $|\mathcal{Z}| = n(n^2 + 1).$

3.3 Moebius-planes over a pair of fields (miquelian Moebius-planes)

3.3.1 The incidence structure $\mathfrak{M}(K, q)$

Looking for further examples of Moebius-planes it seems promising to generalize the classical construction starting with a quadratic form for defining circles in an affine pappian plane. Such Moebius-planes are (as the classical model) characterized by huge homogeneity and the theorem of MIQUEL. If we generalize the space model of the classical Moebius-plane (geometry of plane section of a sphere) by replacing the sphere by an *ovoid* (see Chapter 6 and Section 3.4) in a desarguesian 3-dimensional projective space we get an even wider class of Moebius-planes. The relation between the *miquelian* and *ovoidal* Moebius-planes can be compared with the relation between pappian and desarguesian planes.

Let K be a field and $q(\xi) := \xi^2 + a_0\xi + b_0$, $a_0, b_0 \in K$ an irreducible polynomial over K , i.e. $q(k) \neq 0$ for all $k \in K$. $\rho(x, y) := x^2 + a_0xy + b_0y^2$ is the quadratic form with respect to polynomial q . $\mathfrak{A}(K)$ is (as hitherto) the affine plane over K with point set K^2 and its lines are described by equations $y = mx + b$ and $x = c$ respectively.

$\mathcal{P} := K^2 \cup \{\infty\}$, $\infty \notin K$, the set of points, and

$\mathcal{Z} := \{g \cup \{\infty\} \mid g \text{ line of } \mathfrak{A}(K)\}$

$\cup \{\kappa = \{(x, y) \in K^2 \mid \rho(x, y) + cx + dy + e = 0\} \mid |\kappa| \geq 2, c, d, e \in K\}$ the set of cycles and

$\mathfrak{M}(K, q) := (\mathcal{P}, \mathcal{Z}, \in)$.

In order to show that $\mathfrak{M}(K, q)$ is a Moebius-plane we represent $\mathfrak{M}(K, q)$ (as in the real case) over the splitting field E of polynomial q :

There are $\alpha_1, \alpha_2 \in E$ such that $q(\xi) = (\xi + \alpha_1)(\xi + \alpha_2)$, E is a 2-dimensional vector space over K and $\{1, \alpha_1\}$ and $\{1, \alpha_2\}$ are bases of vector space E , i.e. for any element $\alpha \in E$ there are $k_1, k_2, l_1, l_2 \in K$ such that $\alpha = k_1 + \alpha_1 l_1 = k_2 + \alpha_2 l_2$.

For the product of two elements $\alpha = u + \alpha_1 v$, $\xi = x + \alpha_1 y$ we get:

$$\alpha\xi = ux - b_0vy + \alpha_1(vx + (u + a_0v)y).$$

(Remember: $q(\alpha_1) = \alpha_1^2 - a_0\alpha_1 + b_0 = 0$!)

Remark 3.1 For the classical real Moebius-plane we have $E = \mathbb{C}$, $q(\xi) = \xi^2 + 1$ and $\alpha_1 = i$, $\alpha_2 = -i$.

We shall recognize that it is essential for the geometry $\mathfrak{M}(K, q)$ whether $\alpha_1 = \alpha_2$ (inseparable case) or $\alpha_1 \neq \alpha_2$ (separable case). At first we shall discuss the effect onto the splitting field and the corresponding polynomial:

If q is **separable**, i.e. $\alpha_1 \neq \alpha_2$ then the mapping

$\cdot^- : x + \alpha_1 y \rightarrow x + \alpha_2 y = x + ya_0 - \alpha_1 y$ is an involutorial automorphism of field E and from

$$q(\xi) = (\xi + \alpha_1)(\xi + \alpha_2) = \xi^2 + (\alpha_1 + \alpha_2)\xi + \alpha_1\alpha_2 = \xi^2 + a_0\xi + b_0 \text{ we get:}$$

$$a_0 \neq 0 \text{ if } CharK = 2 \text{ and } 4b_0^2 - a_0^2 \neq 0 \text{ if } CharK \neq 2.$$

If q is **inseparable**, i.e. $\alpha_1 = \alpha_2$ we get from

$q(\xi) = (\xi + \alpha_1)(\xi + \alpha_2) = \xi^2 + 2\alpha_1\xi + \alpha_1^2 = \xi^2 + a_0\xi + b_0$, $a_0 \in K$ and $\alpha_1 \neq 0$ the following statements: $a_0 = 0$, $CharK = 2$ and b_0 is not a square (hence $|K| = \infty$).

3.3.2 Representation of $\mathfrak{M}(K, q)$ over E

A point $(x, y) \in K^2$ can be represented by $\zeta := x + \alpha_1 y \in E$. Thus K^2 can be identified by E and we set $\overline{\mathcal{P}} = E \cup \{\infty\}$. In case of “ q separable” a line can be described by an equation $\alpha\zeta + \overline{\alpha\zeta} + c = 0$ with $\alpha \in E \setminus \{0\}$ and $c \in K$ and a circle by an equation $(\zeta - \mu)(\overline{\zeta - \mu}) = d$. (Remember: $\alpha_2 = a_0 - \alpha_1$, $q(-\alpha_1) = 0$ and $\rho(x, y) = \zeta\overline{\zeta}$ for $\zeta = x + \alpha_1 y$.) In case of “ q inseparable” this advantageous description is not possible, but we have $a_0 = 0$ and $\rho(x, y) = \zeta^2$.

Conclusion: For the considering below we set:

$$\mathcal{P} = E \cup \{\infty\} \quad \text{and}$$

if q is **separable**

$$\begin{aligned} \mathcal{Z} := & \{ \{ \zeta \in E \mid \alpha\zeta + \overline{\alpha\zeta} + c = 0 \} \cup \{\infty\} \mid 0 \neq \alpha \in E, c \in K \} \\ & \cup \{ \kappa = \{ \zeta \in E \mid (\zeta - \mu)\overline{(\zeta - \mu)} = d \} \mid \mu \in E, d \in K, |\kappa| \geq 2 \} \end{aligned}$$

if q is **inseparable**

$$\begin{aligned} \mathcal{Z} := & \{ \{ x + \alpha_1 y \in E \mid ax + by + c = 0 \} \cup \{\infty\} \mid a, b, c \in K, (a, b) \neq (0, 0) \} \\ & \cup \{ \kappa = \{ x + \alpha_1 y \in E \mid x^2 + b_0 y^2 + cx + dy + e = 0 \} \mid c, d, e \in K, |\kappa| \geq 2 \} \end{aligned}$$

3.3.3 Automorphisms of $\mathfrak{M}(K, q)$, $\mathfrak{M}(K, q)$ is Moebius-plane

The advantage describing $\mathfrak{M}(K, q)$ over E is the simple representation of its automorphisms.

Lemma 3.7 *The following mappings of \mathcal{P} are automorphisms of $\mathfrak{M}(K, q)$.*

$$\begin{aligned} (1) : & \begin{cases} \zeta & \rightarrow \delta\zeta, \quad 0 \neq \delta \in E \\ \infty & \rightarrow \infty \end{cases}, & (2) : & \begin{cases} \zeta & \rightarrow \zeta + \tau, \quad \tau \in E \\ \infty & \rightarrow \infty \end{cases}, \\ (3) : & \begin{cases} \zeta & \rightarrow \frac{1}{\zeta}, \quad \zeta \neq 0 \\ 0 & \rightarrow \infty \\ \infty & \rightarrow 0 \end{cases}, & \text{case "q separable":} & (4) : & \begin{cases} \zeta & \rightarrow \overline{\zeta} \\ \infty & \rightarrow \infty \end{cases}. \end{aligned}$$

Proof: a) Let q be separable. In this case the mappings (1), (2) and (4) are obviously automorphisms. Mapping (3) sends the line $\alpha\zeta + \overline{\alpha\zeta} + c = 0$ onto curve $\alpha\overline{\zeta} + \overline{\alpha\zeta} + c\zeta\overline{\zeta} = 0$ which is a line (if $c = 0$) or a circle (if $c \neq 0$). A circle $(\zeta - \mu)\overline{(\zeta - \mu)} = d$ is sent to curve $1 - \mu\zeta - \overline{\mu\zeta} = (d - \mu\overline{\mu})\zeta\overline{\zeta}$ which is a line (if $d = \mu\overline{\mu}$) or a circle (if $d \neq \mu\overline{\mu}$). Because a line $\alpha\zeta + \overline{\alpha\zeta} + c = 0$ or a circle $(\zeta - \mu)\overline{(\zeta - \mu)} = d$ contains point $(0, 0)$ if and only if $c = 0$ or $d = \mu\overline{\mu}$ respectively we get: (3) is an automorphism, too.

b) Now let q be inseparable. In this case we have $\text{Char}K = 2, a_0 = 0$ and $\alpha_1 = \alpha_2$ and for $\delta = u + \alpha_1 v$ and $\zeta = x + \alpha_1 y$ we get $\delta\zeta = ux + b_0 vy + \alpha_1(vx + uy)$. One checks easily that $\zeta \rightarrow \delta\zeta$ sends lines onto lines and circles onto circles. Obviously mapping (2) is an automorphism, too. For the proof that (3) is an automorphism one uses for $\zeta = y + \alpha_1 y \neq 0$ the relation

$$\frac{1}{\zeta} = \frac{\zeta}{\zeta^2} = \frac{x}{x^2 + b_0 y^2} + \alpha_1 \frac{y}{x^2 + b_0 y^2}. \quad \square$$

With the aid of automorphisms (1), (2), (3) one assures oneself of the validity of the following theorem.

Theorem 3.8 *The group $PGL(2, E)$ of fractional linear mappings (Moebius transformations)*

$$\zeta \rightarrow \frac{\alpha\zeta + \beta}{\gamma\zeta + \delta}, \quad \alpha\delta - \beta\gamma \neq 0$$

with its common representation on $E \cup \{\infty\}$ is an automorphism group of structure $\mathfrak{M}(K, q)$.

Theorem 3.9 *Structure $\mathfrak{M}(K, q) = (\mathcal{P}, \mathcal{Z}, \in)$ is a Moebius-plane.*

Proof: The residue \mathfrak{A}_∞ of structure $(\mathcal{P}, \mathcal{Z}, \in)$ obviously is an affine plane. From the transitivity of group $PGL(2, E)$ and Theorem 3.3 we get: $\mathfrak{M}(K, q)$ is a Moebius-plane. \square

The following result due to BENZ, MÄURER, METZ, NOLTE (see [BE'69], [MÄ, ME, NO'80]) shows that we already found all automorphisms of the Moebius-plane $\mathfrak{M}(K, q)$

Result 3.10 (The automorphisms of $\mathfrak{M}(K, q)$) *Any automorphism of Moebius-plane $\mathfrak{M}(K, q)$ has the form:*

$$\zeta \rightarrow \frac{\alpha\zeta + \beta}{\gamma\zeta + \delta} \quad \text{or} \quad \zeta \rightarrow \frac{\alpha\bar{\zeta} + \beta}{\gamma\bar{\zeta} + \delta}, \quad \text{if } q \text{ is separable and}$$

$$\zeta \rightarrow \frac{\alpha\zeta + \beta}{\gamma\zeta + \delta}, \quad \text{if } q \text{ is inseparable}$$

with $\alpha, \beta, \gamma, \delta \in E$ and $\alpha\delta - \beta\gamma \neq 0$.

Hence

Theorem 3.11 *The automorphism group of the Moebius-plane $\mathfrak{M}(K, q)$ operates 3-transitively on the set of points and transitively on the set of cycles.*

If q is inseparable the automorphism group operates even sharply 3-transitive on the set of points.

Remark 3.2 a) *The circles (cycles not containing P) of an arbitrary residue \mathfrak{A}_P are oval conics (see Theorem 2.23).*

b) *In case “Char $K = 2$ and q separable” any circle of residue \mathfrak{A}_P has a knot.*

c) *In case “Char $K = 2$ and q inseparable” any circle of residue \mathfrak{A}_P has parallel tangents (see Section 2.5).*

3.3.4 Cycle reflections

The automorphism (4) gives rise to the following definition.

Definition 3.4 *Any involutorial automorphism of a Moebius-plane \mathfrak{M} which fixes the points of a cycle z is called **reflection at cycle z** .*

Because of Theorem 3.11 we get

Theorem 3.12 *In case of “ q separable” there exists a reflection at any cycle of Moebius-plane $\mathfrak{M}(K, q)$.*

Throughout the following considerations we always assume “ q is separable”. Hence reflections at cycles exist.

In order to find some properties typical for cycle reflections in $\mathfrak{M}(K, q)$ we discuss the reflection $\bar{\sigma}$ at cycle $y = 0$. It induces in residue $\mathfrak{A}_\infty = \mathfrak{A}(K)$ the reflection $\sigma : (x, y) \rightarrow (x + a_0y, -y)$ at the x-axis with center in direction $(a_0, -2)$. A circle $(\zeta - \zeta_0)(\bar{\zeta} - \bar{\zeta}_0) = k$ will be send onto itself if and only if $\zeta_0 \in K$ (proof as in real case). Herewith we find that for any two points $\zeta_1, \zeta_2 \in E \setminus K$ with $\bar{\zeta}_1 \neq \zeta_2$ there is exactly one cycle fixed by $\bar{\sigma}$ containing ζ_1, ζ_2 :

in case of $\zeta_1 - \zeta_2 \in K \cdot (a_0 - 2\alpha_1)$ the fixed cycle is $K \cdot (a_0 - 2\alpha_1) \cup \{\infty\}$,

in case of $\zeta_1 - \zeta_2 \notin K \cdot (a_0 - 2\alpha_1)$ the fixed cycle is $(\zeta - \zeta_0)(\bar{\zeta} - \bar{\zeta}_0) = k$ with $\zeta_0 \in K$.

From the transitivity of the automorphism group of $\mathfrak{M}(K, q)$ (see Theorem 3.11) we get

Lemma 3.13 *Let be q separable, $\bar{\sigma}$ a cycle reflection of $\mathfrak{M}(K, q)$ and A, B two points. Then $A, B, \bar{\sigma}(A), \bar{\sigma}(B)$ lie on a common cycle.*

The importance of this statement shows the following result due to KARZEL, MÄURER ([KA, MÄ'82]).

Result 3.14 *A Moebius-plane \mathfrak{M} is isomorphic to a Moebius-plane $\mathfrak{M}(K, q)$ with separable q if and only if the following holds:*

(CR) *For any cycle z there is a reflection at z .*

(AB) *For any cycle reflection $\bar{\sigma}$ and any two points A, B the four points $A, B, \bar{\sigma}(A), \bar{\sigma}(B)$ lie on a cycle. ($\bar{\sigma}$ is called **inversion**.)*

(For **finite** Moebius-planes property (CR) is sufficient (see [DE'68], p.277).

The following considerations show a further essential property of cycle reflections of a Moebius-plane $\mathfrak{M}(K, q)$:

Conjugation of reflection $\zeta \rightarrow \bar{\zeta}$ (at cycle $K \cup \{\infty\}$) by mapping $\zeta \rightarrow \delta\zeta$, $\delta \in E \setminus \{0\}$ we get the reflection $\zeta \rightarrow \frac{\delta}{\bar{\delta}}\bar{\zeta}$ at cycle $K\delta \cup \{\infty\}$. One easily checks that the product of three of such reflections at cycles containing 0 and ∞ represent a fourth reflection at a cycle containing 0 and ∞ . Because of Theorem 3.11 we get

Lemma 3.15 (Theorem of 3 reflections) *For a Moebius-plane $\mathfrak{M}(K, q)$, q separable, the following statement holds:*

For any three cycles z_1, z_2, z_3 through points $A \neq B$ the product of the reflections at z_1, z_2, z_3 is a reflection at a cycle z_4 through A, B .

Property (AB) of Result 3.14 can be replaced with property (3R) (Theorem of 3 reflections) (see LANG [LA'81]).

Result 3.16 *A Moebius-plane \mathfrak{M} is isomorphic to a Moebius-plane $\mathfrak{M}(K, q)$ with q separable if*

(CR) *For any cycle z there is a reflection at z .*

(3R) *For any three cycles z_1, z_2, z_3 through arbitrary points $A \neq B$ the product of the reflections at z_1, z_2, z_3 is a reflection at a cycle z_4 through A, B .*

3.3.5 Angles in affine plane $\mathfrak{A}(K, q)$

Let be $\mathfrak{A}(K, q)$ the description of affine plane $\mathfrak{A}(K)$ over the splitting field E of polynomial q . With the aid of the multiplication of E we define a measure for angles in $\mathfrak{A}(K, q)$.

Definition 3.5 *Let be g_1, g_2 be lines of an affine plane. The ordered pair $[g_1, g_2]$ is called **angle**.*

In order to get a theorem for $\mathfrak{A}(K, q)$ similar to the *inscribed angle* theorem of the real plane we introduce a suitable measure for angles.

Definition 3.6 *For $0 \neq \zeta \in E$ let be $\langle \zeta \rangle$ the line containing 0 and ζ (in $\mathfrak{A}(K, q)$). On set $G_0 := \{\langle \zeta \rangle \mid 0 \neq \zeta \in E\}$ we define **summation** $+$: For $0 \neq \zeta_1, \zeta_2 \in E$ we set $\langle \zeta_1 \rangle + \langle \zeta_2 \rangle := \langle \zeta_1 \zeta_2 \rangle$.*

Obviously

Lemma 3.17 *$(G_0, +)$ is a commutative group, $K = \langle 1 \rangle$ is the neutral element and for $\langle \zeta \rangle \in G_0$ and “ q separable” $\langle \bar{\zeta} \rangle$ is the inverse element. In case of “ q inseparable” any element $\neq id$ is involutorial. $(G_0, +)$ is isomorphic to $(E^*/K^*, \cdot)$ with $E^* := E \setminus \{0\}, K^* := K \setminus \{0\}$.*

Definition 3.7 *Let be g_1, g_2 lines of $\mathfrak{A}(K, q)$, $\zeta_1, \zeta'_1 \in g_1$ with $\zeta_1 \neq \zeta'_1$ and $\zeta_2, \zeta'_2 \in g_2$ with $\zeta_2 \neq \zeta'_2$ then*

$$\angle(g_1, g_2) := \langle \zeta_1 - \zeta'_1 \rangle - \langle \zeta_2 - \zeta'_2 \rangle = \langle \frac{\zeta_1 - \zeta'_1}{\zeta_2 - \zeta'_2} \rangle$$

is the measure of angle $[g_1, g_2]$.

Remark 3.3 *In [BE'73] BENZ introduces a measure for angles between pairs of cycles using the cross ratio on the projective line $E \cup \{\infty\}$.*

For the measurement of angles of triangles we give a further definition:

Definition 3.8 *For any three points $\zeta_1, \zeta_2, \zeta_3 \in E$ we set*

$$\angle(\zeta_1, \zeta_2, \zeta_3) := \langle \zeta_1 - \zeta_2 \rangle - \langle \zeta_3 - \zeta_2 \rangle = \langle \frac{\zeta_1 - \zeta_2}{\zeta_3 - \zeta_2} \rangle.$$

For the sum of the angles of a triangle we get

Lemma 3.18 *For any three points $\zeta_1, \zeta_2, \zeta_3 \in E$ we have*

$$\angle(\zeta_1, \zeta_2, \zeta_3) + \angle(\zeta_2, \zeta_3, \zeta_1) + \angle(\zeta_3, \zeta_1, \zeta_2) = 0.$$

Comparing the last statement with the well known one in the real case one has to take into account that the measure for angles defined above matches the real one modulo 180° .

Now we shall prove a theorem analogous to the “inscribed angle theorem” which gives us a tool to characterize 4 points on a circle in $\mathfrak{A}(K, q)$.

Definition 3.9 A point set of $\mathfrak{A}(K, q)$ which fulfills an equation of the form

$$x^2 + a_0xy + b_0y^2 + cx + dy + e = 0$$

and contains at least two points is called **circle of $\mathfrak{A}(K, q)$** .

Theorem 3.19 (4 points on a circle) Four points $\zeta_1, \zeta_2, \zeta_3, \zeta_4 \in E$ lie on a circle of $\mathfrak{A}(K, q)$ if no three are collinear and if $\angle(\zeta_1, \zeta_3, \zeta_2) = \angle(\zeta_1, \zeta_4, \zeta_2)$

Proof: We shall show that the condition $\angle(\zeta_1, \zeta_3, \zeta_2) = \angle(\zeta_1, \zeta_4, \zeta_2)$ for points $\zeta_i = x_i + \alpha_1 y_i, i = 1, 2, 3, 4$ is equivalent to the fact that their coordinates x_i, y_i satisfy an equation $x^2 + a_0xy + b_0y^2 + cx + dy + e = 0$.

For the points $\zeta_1, \zeta_2, \zeta_3, \zeta_4$, no three collinear, we suppose $\angle(\zeta_1, \zeta_3, \zeta_2) = \angle(\zeta_1, \zeta, \zeta_2)$, i.e. $\langle \frac{\zeta_1 - \zeta_3}{\zeta_2 - \zeta_3} \rangle = \langle \frac{\zeta_1 - \zeta}{\zeta_2 - \zeta} \rangle$. In order to cover both cases “ q separable” and “ q inseparable” we declare the mapping $\bar{\cdot}$ as identity if q is inseparable. Hence $\langle \frac{\zeta_1 - \zeta_3}{\zeta_2 - \zeta_3} \rangle = \langle (\zeta_1 - \zeta) \overline{(\zeta_2 - \zeta)} \rangle$ because of Lemma 3.17. For $\zeta_i = x_i + \alpha_1 y_i, \alpha_1 \alpha_2 = b_0, \alpha_1 + \alpha_2 = a_0$ and the abbreviations $x_{ik} := x_i - x_k$ and $y_{ik} := y_i - y_k$ we get $(\zeta_1 - \zeta_3) \overline{(\zeta_2 - \zeta_3)} = x_{13}x_{23} + a_0x_{13}y_{23} + b_0y_{13}y_{23} + \alpha_1(y_{13}x_{23} - y_{23}x_{13})$. Because $\zeta_1, \zeta_2, \zeta_3$ are not collinear we have $y_{13}x_{23} - y_{23}x_{13} \neq 0$. The analogous consideration for $(\zeta_1 - \zeta) \overline{(\zeta_2 - \zeta)}$ yields:

$$\frac{x_{13}x_{23} + a_0x_{13}y_{23} + b_0y_{13}y_{23}}{y_{13}x_{23} - y_{23}x_{13}} = \frac{(x_1 - x)(x_2 - x) + a_0(x_1 - x)(y_2 - y) + b_0(y_1 - y)(y_2 - y)}{(y_1 - y)(x_2 - x) - (y_2 - y)(x_1 - x)}$$

which is the “3-point-form” of the circle through $\zeta_1, \zeta_2, \zeta_3$ and hence equivalent to an equation of the form $x^2 + a_0xy + b_0y^2 + cx + dy + e = 0$ and the coordinates of $\zeta_1, \zeta_2, \zeta_3$ fulfill this equation.

Hence the equation $\angle(\zeta_1, \zeta_3, \zeta_2) = \angle(\zeta_1, \zeta_4, \zeta_2)$ is equivalent to the fact that ζ lies on the circle determined by $\zeta_1, \zeta_2, \zeta_3$.

(For the classical real case the left hand side of the 3-point-form is the cotangens of the angle at P_3 .) \square

3.3.6 Theorem of MIQUEL in $\mathfrak{M}(K, q)$

With the aid of Theorem 3.19 we shall proof the Theorem of MIQUEL and a degeneration of it in the Moebius-plane $\mathfrak{M}(K, q)$.

Theorem 3.20 (Theorem of MIQUEL) For the Moebius-plane $\mathfrak{M}(K, q)$ the following is true:

If for any 8 points P_1, \dots, P_8 which can be assigned to the vertices of a cube such that the points in 5 faces correspond to concyclical quadruples than the sixth quadruple of points is concyclical, too.

Proof: Because of the transitivity of the automorphism group of $\mathfrak{M}(K, q)$ we shall confine on the case $P_8 = \infty$. We use for \mathcal{P} the representation over the splitting field E of polynomial q . Hence $P_i \in E$ for $i = 1, \dots, 7$. With the abbreviation $m_{ik} = \langle P_i - P_k \rangle$ (see Section 3.3.5) we get from Theorem 3.17 (see Fig. 3.3):

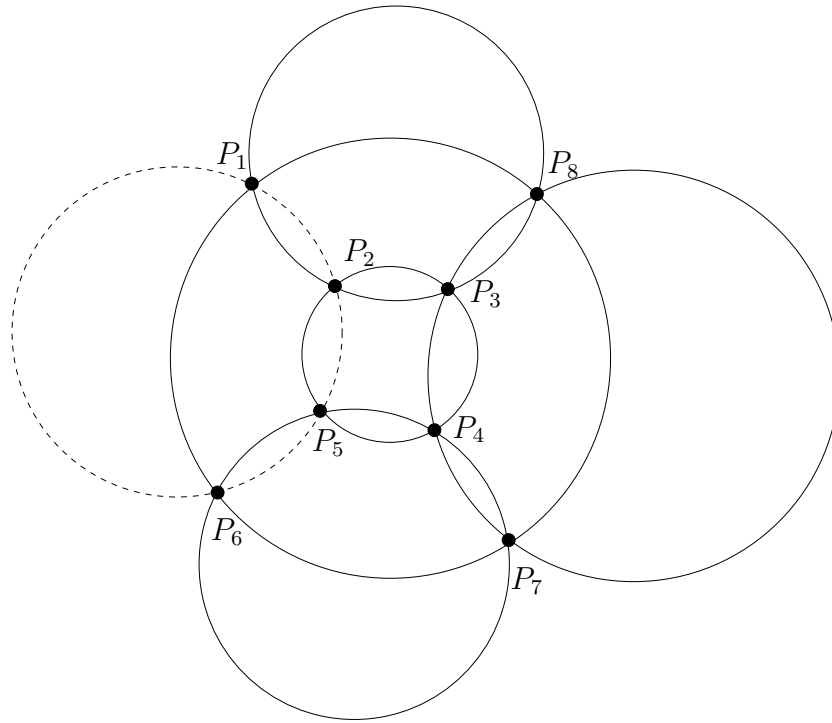

Figure 3.2: Theorem of Miquel for Moebius-plane $\mathfrak{M}(K, q)$

$m_{65} - m_{45} = m_{67} - m_{47}, m_{45} - m_{25} = m_{43} - m_{23}$ and , because of collinearity (see Fig.3.3),

$m_{16} = m_{67}, m_{43} = m_{47}, m_{12} = m_{23}$. Combining these equations leads to:

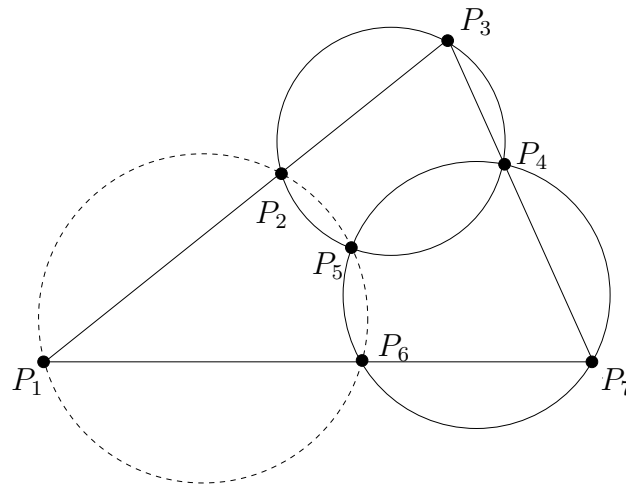

Figure 3.3: Proof of theorem of Miquel for Moebius-plane $\mathfrak{M}(K, q)$

$m_{65} - m_{25} = m_{45} + m_{67} - m_{47} - m_{25} = m_{25} + m_{43} - m_{23} + m_{67} - m_{47} - m_{25} = m_{61} - m_{21}$.

With Theorem 3.19 we conclude: P_1, P_2, P_5, P_6 lie on a common cycle. \square

Theorem 3.21 (7-point-MIQUEL) *In case of $P_4 = P_5$ Theorem 3.20 is still true.*

Proof: We describe \mathcal{P} over E and assume (without loss of generality) $P_4 = P_5 = \infty$. Then from Figure 3.4 we get for $m_{ik} := \langle P_i - P_k \rangle$ (see Theorem 3.19):

$m_{16} - m_{18} = m_{76} - m_{78}$, $m_{18} - m_{12} = m_{38} - m_{32}$ and $m_{23} = m_{76}$, $m_{78} = m_{38}$. Hence $m_{16} = m_{18} + m_{76} - m_{78} = m_{18} + m_{23} - m_{38} = m_{12} + m_{38} - m_{32} + m_{23} - m_{38} = m_{12}$ and $P_1, P_2, P_4 = P_5$ and P_6 are concyclical. \square

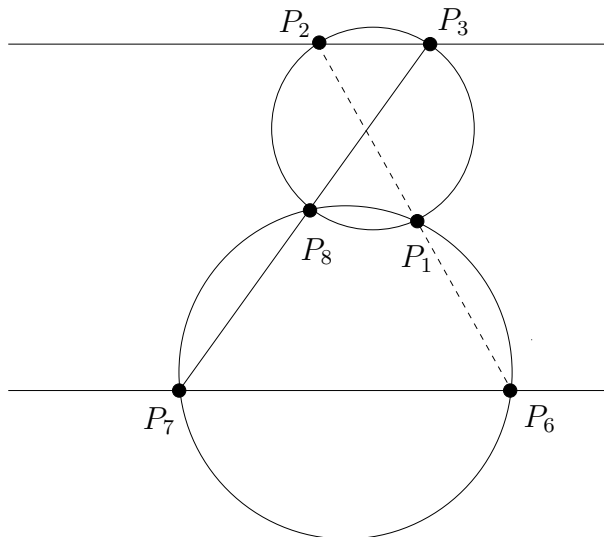

Figure 3.4: Proof 7-point degeneration of theorem of Miquel

The importance of these Theorems was recognized by v.d. WAERDEN:

Result 3.22 (v.d. WAERDEN & SMID, [WA,SM'35]) *For a Moebius-plane \mathfrak{M} which satisfies the Theorem of MIQUEL and its 7-point-version there exists a field K and an irreducible polynomial $q(\xi) = \xi^2 + a_0\xi + b_0$, $a_0, b_0 \in K$ such that \mathfrak{M} is isomorphic to $\mathfrak{M}(K, q)$.*

Result 3.23 (CHEN, [CH'70]) *Result 3.22 is still true if one presumes the validity of the Theorem of MIQUEL without the 7-point-version.*

Because of these results we call a Moebius-plane **miquelian** if it is isomorphic to a Moebius-plane $\mathfrak{M}(K, q)$.

Remark 3.4 a) *The minimal-model of a Moebius-plane is miquelian. It is isomorphic to $\mathfrak{M}(K, q)$ with $K = GF(2)$, $E = GF(4)$ and $q(\xi) = \xi^2 + \xi + 1$.*

b) *As for Minkowski-planes (see Section 5.3.5) the Theorem of MIQUEL can be deduced in case of "q separable" from the existence of cycle reflections and the validity of the 3-reflection-theorem (see Result 3.16).*

3.3.7 The sphere-model of a miquelian Moebius-plane

A Moebius-plane $\mathfrak{M}(K, q)$ with $\mathcal{P} := K^2 \cup \{\infty\}$ can be embedded into $K^3 \cup \{\infty\}$ by the following mapping:

$$\text{Let be } \varphi : \begin{cases} (x, y) & \rightarrow (x, y, \rho(x, y)) \\ \infty & \rightarrow \infty \end{cases}$$

(Where ρ is the corresponding quadratic form to polynomial q .)

Hence φ sends K^2 onto the “paraboloid” $z = \rho(x, y)$. A line $ax + by + c = 0$ is sent to the plane of K^3 with the same equation, a circle $\rho(x, y) + ax + by + c = 0$ to the section of the paraboloid with the plane $z + ax + by + c = 0$.

The projective sphere-model

We identify ∞ with the point of infinity of the z -axis and introduce homogeneous coordinates x_1, x_2, x_3, x_4 such that $x = x_1/x_4, y = x_2/x_4, z = x_3/x_4$ (i.e. equation $x_4 = 0$ describes the plane at infinity). Hence $\varphi(\mathcal{P})$ can be represented totally by the equation $\rho(x_1, x_2) - x_3x_4 = 0$ (where $\varphi(\infty) = \langle (0, 0, 1, 0) \rangle$) and for $\mathcal{P}' := \varphi(\mathcal{P})$ and $\mathcal{Z}' := \varphi(\mathcal{Z})$ we get:

$$\begin{aligned} \mathcal{P}' &= \{ \langle (x_1, x_2, x_3, x_4) \rangle \mid (x_1, x_2, x_3, x_4) \neq (0, 0, 0, 0) \text{ and } \rho(x_1, x_2) - x_3x_4 = 0 \} \\ \mathcal{Z} &= \{ \mathcal{P}' \cap \varepsilon \mid \varepsilon : \text{plane with } |\mathcal{P}' \cap \varepsilon| \geq 3 \}. \end{aligned}$$

Remark 3.5 a) \mathcal{P}' is a quadric of index 1, i.e. \mathcal{P}' is an ovoid (see Chapter 6).

b) In case of q inseparable the bilinear form $f(\mathbf{x}, \mathbf{x}') = \bar{\rho}(\mathbf{x} + \mathbf{x}') - \bar{\rho}(\mathbf{x}) - \bar{\rho}(\mathbf{x}')$ corresponding to the quadratic form $\bar{\rho}$ with $\bar{\rho}(\mathbf{x}) = \rho(x_1, x_2) - x_3x_4$ simplifies to $f(\mathbf{x}, \mathbf{x}') = x_3x'_4 + x_4x'_3$ because ρ is “quasi linear” (i.e. $\rho(\mathbf{x} + \mathbf{x}') = \rho(\mathbf{x}) + \rho(\mathbf{x}')$). Hence in this case the bilinear form f has the “ f -radical” $\mathcal{R} = \{ \langle (x_1, x_2, 0, 0) \rangle \mid (x_1, x_2) \neq (0, 0) \}$ (see Chapter 6) and any tangent plane of the ovoid with the equation $\rho(x_1, x_2) + x_3x_4 = 0$ contains the line \mathcal{R} .

Affine model

Let be $K \setminus \rho(K^2) \neq \emptyset$ and $r_0 \in K \setminus \rho(K^2)$. In this case the paraboloid $z = \rho(x, y)$ together with point ∞ can be mapped onto a “sphere”, i.e. ovoidal quadric in affine space K^3 :

Let be ψ the perspective mapping with axis $z = 0$ and

$$(x, y, z) \rightarrow \left(\frac{r_0x}{r_0 - z}, \frac{r_0y}{r_0 - z}, \frac{z}{z - r_0} \right), \quad z \neq r_0.$$

The points of the paraboloid together with point ∞ are sent onto the points of the sphere with equation $\rho(x, y) + r_0z(1 - z) = 0$. Hence for $\mathcal{P}'' := \psi(\mathcal{P}')$ and $\mathcal{Z}'' := \psi(\mathcal{Z}')$ we get:

$$\mathcal{P}'' = \{ (x, y, z) \in K^3 \mid \rho(x, y) + r_0z(1 - z) = 0 \} \text{ and } \mathcal{Z}'' = \{ \mathcal{P}'' \cap \varepsilon \mid \varepsilon : \text{plane with } |\mathcal{P}'' \cap \varepsilon| \geq 3 \}.$$

$\varepsilon| \geq 3\}$

(For the real case one may choose $\rho(x, y) = x^2 + y^2$ and $r_0 = -1$.)

The bijection
$$\begin{cases} (x, y) & \rightarrow \left(\frac{r_0 x}{r_0 - \rho(x, y)}, \frac{r_0 y}{r_0 - \rho(x, y)}, \frac{\rho(x, y)}{\rho(x, y) - r_0} \right) \\ \infty & \rightarrow (0, 0, 1) \end{cases}$$

between $K^2 \cup \{\infty\}$ and the sphere $\rho(x, y) + r_0 z(1 - z) = 0$ in K^3 is called **stereographic projection**.

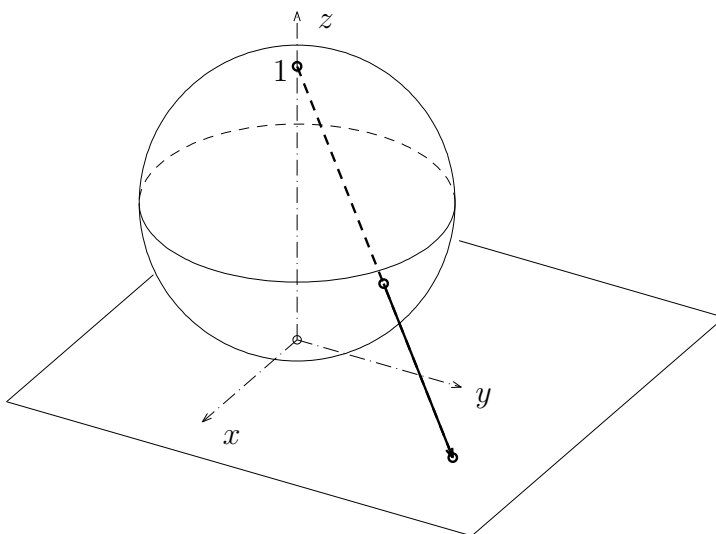

Figure 3.5: Stereographic projection

3.3.8 Isomorphic miquelian Moebius-planes

For two isomorphic Moebius-planes $\mathfrak{M}(K, q) := (\mathcal{P}, \mathcal{Z}, \in)$ and $\mathfrak{M}(K', q') := (\mathcal{P}', \mathcal{Z}', \in)$ all residues (affine planes) are isomorphic and even the fields K and K' are isomorphic, too. Hence for the following considerations we start with Moebius-planes $\mathfrak{M}(K, q)$ and $\mathfrak{M}(K, q')$ over the same field K .

Case I: $\text{Char} K \neq 2$ (hence q is separable)

A Moebius-plane $\mathfrak{M}(K, q)$ with $q(\xi) = \xi^2 + a_0\xi + b_0$ can be mapped onto $\mathfrak{M}(K, \bar{q})$ with $\bar{q}(\xi) = \xi^2 + \bar{b}_0$ and $\bar{b}_0 = b_0 - a_0^2/4$ by a suitable coordinate transformation.

For two isomorphic Moebius-planes $\mathfrak{M}(K, q)$ and $\mathfrak{M}(K, q')$ with $q(\xi) = \xi^2 + b_0$ and $q'(\xi) = \xi^2 + b'_0$ there exists (because of Theorem 3.11) a bijection $\bar{\psi}$ of $K^2 \cup \{\infty\}$ onto itself such that $\bar{\psi}(\infty) = \infty$, $\bar{\psi}((0, 0)) = (0, 0)$ and $\bar{\psi}((1, 0)) = (1, 0)$ which induces for \mathfrak{A}_∞ a collineation $\psi : (x, y) \rightarrow (a\alpha(x) + b\alpha(y), c\alpha(x) + d\alpha(y))$ (α is an automorphism of field K) which sends circles (in \mathfrak{A}_∞) corresponding to polynomial q onto circles corresponding to q' . This is possible only if $c = 0$ (x-axis is fixed !), $b = 0$ (the quadratic

form ρ' contains no mixed part $\cdots xy$) and $b'_0 = (\frac{a}{b})^2 \alpha(b_0)$.

Conclusion: $\mathfrak{M}(K, q)$ and $\mathfrak{M}(K, q')$ are isomorphic Moebius-planes if and only if there exists $k \in K$ and a field automorphism α such that $b'_0 = k^2 \alpha(b_0)$.

Case II: $\text{Char}K = 2$ and q separable

A Moebius-plane $\mathfrak{M}(K, q)$ with $q(\xi) = \xi^2 + a_0\xi + b_0$ can be mapped onto $\mathfrak{M}(K, \bar{q})$ with $\bar{q}(\xi) = \xi^2 + \xi + \bar{b}_0$ and $\bar{b}_0 = b_0/a_0^2$ by a suitable coordinate transformation.

For two isomorphic Moebius-planes $\mathfrak{M}(K, q)$ and $\mathfrak{M}(K, q')$ with $q(\xi) = \xi^2 + \xi + b_0$ and $q'(\xi) = \xi^2 + \xi + b'_0$ considerations analogous to Case I yield:

$\mathfrak{M}(K, q)$ and $\mathfrak{M}(K, q')$ are isomorphic Moebius-planes if and only if there exists $k \in K$ and a field automorphism α such that $b'_0 = k^2 + k + \alpha(b_0)$.

Case III: $\text{Char}K = 2$ and q inseparable

For two isomorphic Moebius-planes $\mathfrak{M}(K, q)$ and $\mathfrak{M}(K, q')$ with $q(\xi) = \xi^2 + b_0$ and $q'(\xi) = \xi^2 + b'_0$ considerations analogous to Case I yield:

$\mathfrak{M}(K, q)$ and $\mathfrak{M}(K, q')$ are isomorphic Moebius-planes if and only if there exist $r, s \in K$ and a field automorphism α such that $b'_0 = r^2 + \alpha(b_0)s^2$.

3.4 Ovoidal Moebius-planes

From the sphere model of a miquelian Moebius-plane the following question arises:

In 3-dimensional projective space are there point sets different to spheres (quadrics of index 1) such that their plane sections lead to a Moebius-plane? An answer gives the following theorem:

Theorem 3.24 *Let be \mathcal{P} a 3-dimensional projective space and \mathfrak{o} an ovoid (see Chapter 6) then the incidence structure $\mathfrak{M}(\mathfrak{o}) := (\mathcal{P}, \mathcal{Z}, \in)$ with*

$\mathcal{P} := \mathfrak{o}$ and

$\mathcal{Z} := \{\mathfrak{o} \cap \varepsilon \mid \varepsilon \text{ plane with } |\mathfrak{o} \cap \varepsilon| \geq 3\}$

is a Moebius-plane.

The proof is a simple consequence of the definition of an ovoid (see Chapter 6).

Definition 3.10 *A Moebius-plane which can be described as the geometry of the plane sections of an ovoid in a projective 3-space (see Theorem 3.24) is called **ovoidal**.*

Before discussing examples we present the essential theorem which characterizes these Moebius-planes:

Theorem 3.25 (Bundle Theorem) *For an ovoidal Moebius-plane the following statement holds:*

Let be $A_1, A_2, A_3, A_4, B_1, B_2, B_3, B_4$ eight points such that 5 of the six quadruples

$$Q_{ij} := \{A_i, B_i, A_j, B_j\}, \quad i < j,$$

are concyclical on at least 4 cycles k_{ij} . Then the last quadruple is concyclical, too.

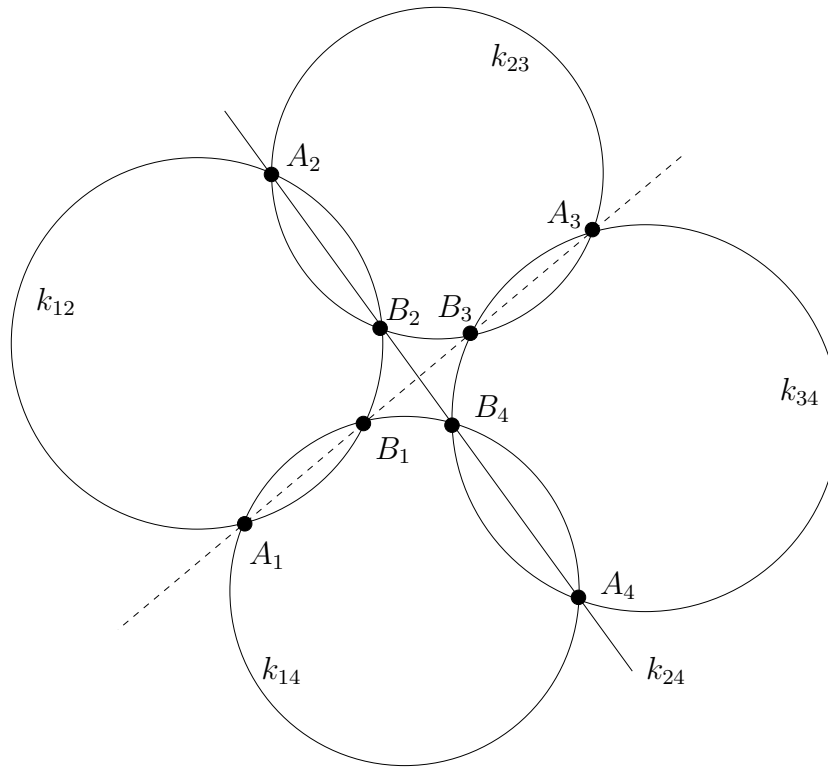

Figure 3.6: Bundle Theorem

Proof: Let be $\mathfrak{M}(\mathfrak{o})$ the representation of \mathfrak{M} as the geometry of plane sections of ovoid \mathfrak{o} in projective 3-space \mathfrak{P} (see Theorem 3.24). We assume the quadruples $Q_{12}, Q_{23}, Q_{34}, Q_{14}, Q_{24}$ to be concyclical and the corresponding cycles $k_{12}, k_{23}, k_{34}, k_{14}, k_{24}$ to be different. Let be g_i the line (in \mathfrak{P}) through A_i, B_i . If the lines g_1, g_2, g_3, g_4 have a point P (in \mathfrak{P}) in common the statement is obviously true. Otherwise one deduces that the cycles $k_{12}, k_{23}, k_{34}, k_{14}, k_{24}$ can not be different in contradiction to the assumption above. \square

The importance of the Bundle Theorem shows the following result.

Result 3.26 (KAHN, [KH'80]) *A Moebius-plane is ovoidal if and only if the Bundle Theorem (Theorem 3.25) holds.*

The meaning of the Bundle Theorem can be compared with the Theorem of Desargues for projective/affine planes. Because, for a Moebius-plane fulfilling the Bundle Theorem, there exists a skewfield K and an ovoid \mathfrak{o} in the projective 3-space over K such that \mathfrak{M} is isomorphic to the Moebius-plane $\mathfrak{M}(\mathfrak{o})$. If the Theorem of Miquel is fulfilled the skewfield is even commutative and the ovoid is a quadric. Hence the meaning of the Theorem of Miquel can be compared with the Theorem of Pappus.

Because any quadric of index 1 in projective 3-space is an ovoid (see Chapter 6) we get

Theorem 3.27 *Any miquelian Moebius-plane is ovoidal, i.e. the Bundle Theorem is a consequence of the Theorem of Miquel.*

For finite Moebius-planes we even have

Result 3.28 (DEMBOWSKI, [DE'64]) *Any finite Moebius-plane of even order is ovoidal.*

(See also [BP'83].)

3.4.1 Plane model of an ovoidal Moebius-plane

Let be \mathfrak{P} a projective 3-space, \mathfrak{o} an ovoid, $\mathfrak{M}(\mathfrak{o})$ the corresponding ovoidal Moebius-plane, $P, Q \in \mathfrak{o}, P \neq Q$ and $\varepsilon_P, \varepsilon_Q$ the tangent planes at P, Q respectively. \mathfrak{P} can be described over a skewfield K with homogeneous coordinates such that $P = \langle (0, 0, 1, 0) \rangle$, ε_P is plane $x_4 = 0$, $Q = \langle (0, 0, 0, 1) \rangle$ and ε_Q is plane $x_3 = 0$. Ovoid \mathfrak{o} can be described by a function f of K^2 in K : $\mathfrak{o} = \{ \langle (x, y, f(x, y), 1) \rangle \mid x, y \in K \} \cup \{ \langle (0, 0, 1, 0) \rangle \}$. Hence equation $z = f(x, y)$ represents in K^3 a "parabolic surface" which contains point $(0, 0, 0)$ and x-y-plane is the tangent plane at $(0, 0, 0)$.

Projecting $\mathfrak{o} \setminus \{P\}$ from point P onto plane ε_Q together with $\infty = P$ yields a plane model $(\mathcal{P}', \mathcal{Z}', \in)$ of Moebius-plane $\mathfrak{M}(\mathfrak{o})$ which can be described in K^2 in the following way:

$$\mathcal{P}' = K^2 \cup \{\infty\}$$

$$\mathcal{Z}' = \{ \{ (x, y) \in K^2 \mid ax + by + c = 0 \} \cup \{\infty\} \mid a, b, c \in K, (a, b) \neq (0, 0) \} \\ \cup \{ \kappa = \{ (x, y) \in K^2 \mid f(x, y) + cx + dy + e = 0 \} \mid c, d, e \in K, |\kappa| \geq 3 \}$$

(Where $f(x, y) = 0$ if and only if $(x, y) = (0, 0)$.)

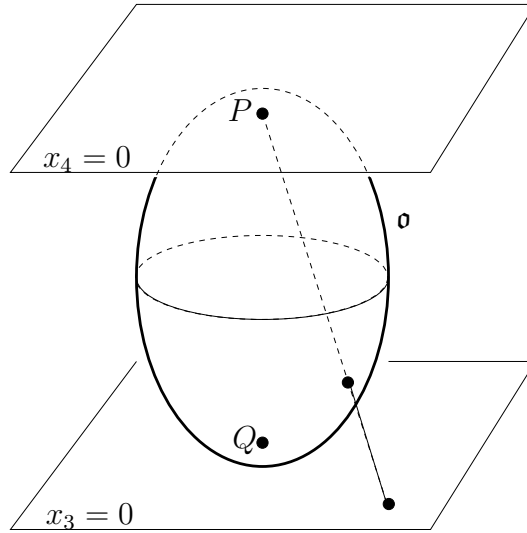

Figure 3.7: Plane model of an ovoidal Moebius-plane

Remark 3.6 *Examples for suitable functions f (especially for the real case) are contained in Section 6.3.*

3.4.2 Examples of ovoidal Moebius-planes

It suffice to give ovoids in a projective 3-space. In the real case there are a lot of possibilities to construct ovoids which are no quadrics (see Chapter 6). For the finite case we get from the Theorem of SEGRE (2.27): Any ovoid in a projective 3-space of odd order is already a quadric (see Chapter 6). Hence:

Theorem 3.29 *Any finite ovoidal Moebius-plane of **odd** order is miquelian.*

The Moebius-planes of **even** order known until now are either miquelian or ovoidal over a *TITS-SUZUKI-ovoid* (see Chapter 6). Such an ovoid exists for any field $GF(2^n)$ with “ n odd”:

Using the mapping $\sigma : x \rightarrow x^{(2^{\frac{n+1}{2}})}$ the cycles of the plane model (of the Moebius-plane) which do not contain point ∞ can be described by an equation $x^\sigma x^2 + xy + y^\sigma + ax + by + c = 0$.

In case of “ $n = 1$ ” only we get a miquelian Moebius-plane (minimal model).

One gets further examples of non miquelian ovoidal Moebius-planes with good algebraic representations if one uses the *Moufang-ovoids* of TITS (see [TI’62]) which exist for certain infinite fields of characteristic 2.

Finally it should be mentioned that for any infinite projective 3-space there exist ovoids which are constructed by *transfinite induction* (see [HE’71], p. 210). Hence the class of ovoidal Moebius-planes is rather rich.

3.5 Non ovoidal Moebius-planes

All examples of non ovoidal Moebius-planes are due to EWALD (see [EW’67]). We give one class of such examples:

Let be \mathfrak{k} a strongly convex, differentiable, closed curve of the real affine plane $\mathfrak{A}(\mathbb{R})$ and Δ_+ the group of dilatations with a positive scalefactor: $(x, y) \rightarrow (ax + s, ay + t)$, $a > 0$ and

$$\mathcal{P} := \mathbb{R}^2 \cup \{\infty\}, \quad \infty \notin \mathbb{R},$$

$$\mathcal{Z} := \{\{\delta(\mathfrak{k}) \mid \delta \in \Delta_+\} \cup \{g \cup \{\infty\} \mid g \text{ line of } \mathfrak{A}(\mathbb{R})\}\}.$$

Then: $(\mathcal{P}, \mathcal{Z}, \in)$ is a Moebius-plane.

(See also [GR’74c].)

3.6 Final remark

Further results on Moebius–planes can be found in the books of BENZ [BE'73] and DEMBOWSKI [DE'68].

Chapter 4

LAGUERRE–PLANES

Literature: [BE'73]

4.1 The classical real Laguerre–plane

Originally the classical Laguerre–plane was defined as the geometry of the oriented lines and circles in the real euclidean plane (see BENZ [BE'73]). Here we prefer the parabola model considering the Moebius–plane as the geometry of the circles, the Laguerre–plane the geometry of parabolas and the Minkowski–plane the geometry of hyperbolas in the real plane.

Let be $\mathfrak{A}(\mathbb{R})$ the real affine plane with its common coordinatization. In order to homogenize the geometry of the parabolas $y = ax^2 + bx + c$, $a, b, c \in \mathbb{R}$ (in case of $a \neq 0$ parabolas, in case of $a = 0$ lines) it is convenient to introduce the curvature factors as additional points. We get basic properties for incidence similar to the Moebius–plane.

We define:

$\mathcal{P} := (\mathbb{R} \cup \{\infty\}) \times \mathbb{R} = \mathbb{R}^2 \cup (\{\infty\} \times \mathbb{R})$, $\infty \notin \mathbb{R}$, the set of **points**,

$\mathcal{Z} := \{(x, y) \in \mathbb{R}^2 \mid y = ax^2 + bx + c\} \cup \{(\infty, a) \mid a, b, c \in \mathbb{R}\}$ the set of **cycles**.

The incidence structure $(\mathcal{P}, \mathcal{Z}, \in)$ is called **classical real Laguerre–plane**.

Unlike to Moebius–planes there exist pairs of points which cannot be connected by cycles. Hence we define: Two points A, B are **parallel** ($A \parallel B$) if $A = B$ or there is no cycle containing A and B . For the description of the classical real Laguerre–plane above two points $(a_1, a_2), (b_1, b_2)$ are parallel if and only if $a_1 = b_1$. Obviously \parallel is an equivalence relation.

The incidence structure $(\mathcal{P}, \mathcal{Z}, \in)$ has the following properties:

Lemma 4.1 a) For any three points A, B, C , pairwise not parallel, there is exactly one cycle z containing A, B, C .

b) For any point P and any cycle z there is exactly one point $P' \in z$ such that $P \parallel P'$.

c) For any cycle z , any point $P \in z$ and any point $Q \notin z$ which is not parallel to P there is exactly one cycle z' through P, Q with $z \cap z' = \{P\}$, i.e. “ z and z' **touch** each other at P ”.

Proof: a) and b) are obvious. The validity of c) is recognized easily if one uses the transitivity of the automorphism group of $(\mathcal{P}, \mathcal{Z}, \in)$ and by setting $P = (\infty, 0)$. Now c) is equivalent to the parallel axiom of the affine plane $\mathfrak{A}(\mathbb{R})$. The transitivity is a consequence of the fact that the translations $(x, y) \rightarrow (x + s, y + t)$ and the mapping $(x, y) \rightarrow (\frac{1}{x}, \frac{y}{x^2})$, $x \neq 0$ can be extended to automorphisms of $(\mathcal{P}, \mathcal{Z}, \in)$ (see Section 4.3.2). \square

Similar to the sphere model of the classical real Moebius-plane there is a space model for the classical Laguerre-plane: $(\mathcal{P}, \mathcal{Z}, \in)$ is isomorphic to the geometry of plane sections of a circular cylinder in \mathbb{R}^3 (see Section 4.4).

4.2 The axioms of a Laguerre-plane

Lemma 4.1 gives rise to the following definition:

Definition 4.1 Let $\mathfrak{L} = (\mathcal{P}, \mathcal{Z}, \in)$ be an incidence structure with **point set** \mathcal{P} and **set of cycles** \mathcal{Z} . Two points A, B are **parallel** ($A \parallel B$) if $A = B$ or there is no cycle containing A and B . \mathfrak{L} is called **Laguerre-plane** if the following axioms hold:

B1: For any three points A, B, C , pairwise not parallel, there is exactly one cycle z which contains A, B, C .

B2: For any point P and any cycle z there is exactly one point $P' \in z$ such that $P \parallel P'$.

B3: For any cycle z , any point $P \in z$ and any point $Q \notin z$ which is not parallel to P there is exactly one cycle z' through P, Q with $z \cap z' = \{P\}$, i.e. “ z and z' **touch** each other at P ”.

B4: Any cycle contains at least three points, there is at least one cycle. There are at least four points not on a cycle.

Four points A, B, C, D are **concylic** if there is a cycle z with $A, B, C, D \in z$.

From the definition of relation \parallel and axiom *B2* we get

Lemma 4.2 Relation \parallel is an equivalence relation.

Following the cylinder model of the classical Laguerre-plane we introduce the denotation:

Definition 4.2 a) For $P \in \mathcal{P}$ we set $\overline{P} := \{Q \in \mathcal{P} \mid P \parallel Q\}$.
 b) An equivalence class \overline{P} is called **generator**.

The connection to linear geometry is given by

Definition 4.3 For a Laguerre-plane $\mathfrak{L} = (\mathcal{P}, \mathcal{Z}, \in)$ and $P \in \mathcal{P}$ we define $\mathfrak{A}_P := (\mathcal{P} \setminus \{\overline{P}\}, \{z \setminus \{\overline{P}\} \mid P \in z \in \mathcal{Z}\} \cup \{\overline{Q} \mid Q \in \mathcal{P} \setminus \{\overline{P}\}\}, \in)$ and call it the **residue at point P**.

One easily checks the validity of the following statements

Theorem 4.3 a) Any residue of a Laguerre-plane is an affine plane. b) Let be $P \in \mathcal{P}$, z a cycle with $P \notin z$. Then $z \setminus \{\overline{P}\}$ is a parabolic curve of \mathfrak{A}_P (see Section 2.1).

Theorem 4.4 An incidence structure together with an equivalence relation \parallel on \mathcal{P} is a Laguerre-plane if and only if for any point P the incidence structure

$$\mathfrak{A}_P := (\mathcal{P} \setminus \{\overline{P}\}, \{z \setminus \{\overline{P}\} \mid P \in z \in \mathcal{Z}\} \cup \{\overline{Q} \mid Q \in \mathcal{P} \setminus \{\overline{P}\}\}, \in)$$

with $\overline{P} := \{Q \in \mathcal{P} \mid P \parallel Q\}$ is an affine plane.

The following incidence structure is a **minimal model** of a Laguerre-plane:

$\mathcal{P} := \{A_1, A_2, B_1, B_2, C_1, C_2\}$
 $\mathcal{Z} := \{\{A_i, B_j, C_k\} \mid i, j, k = 1, 2\}$
 $A_1 \parallel A_2, B_1 \parallel B_2, C_1 \parallel C_2$.
 Hence $|\mathcal{P}| = 6$ and $|\mathcal{Z}| = 8$.

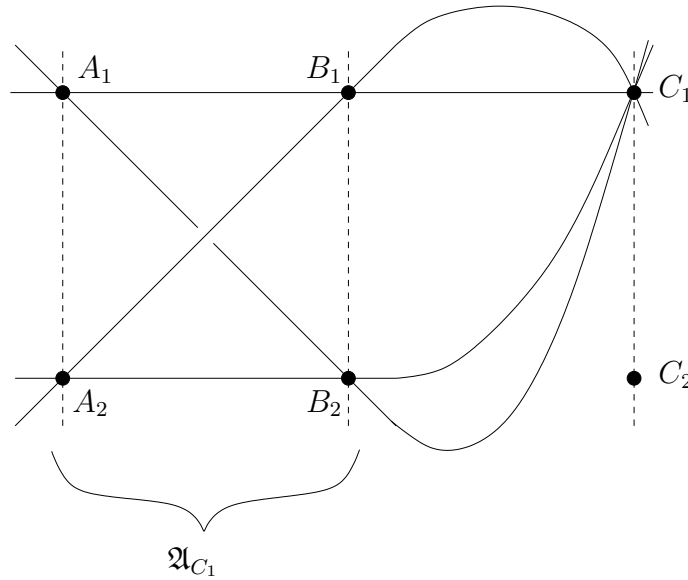

Figure 4.1: Minimal model of a Laguerre-plane

For finite Laguerre-planes, i.e. $|\mathcal{P}| < \infty$, we get:

Lemma 4.5 *For any cycles z_1, z_2 and any generator \overline{P} of a finite Laguerre-plane $\mathfrak{L} = (\mathcal{P}, \mathcal{Z}, \in)$ we have: $|z_1| = |z_2| = |\overline{P}| + 1$.*

Definition 4.4 *For a finite Laguerre-plane $\mathfrak{L} = (\mathcal{P}, \mathcal{Z}, \in)$ and a cycle $z \in \mathcal{Z}$ the integer $n := |z| - 1$ is called **order** of \mathfrak{L} .*

From combinatorics we get

Lemma 4.6 *Let $\mathfrak{L} = (\mathcal{P}, \mathcal{Z}, \in)$ be a Laguerre-plane of order n . Then*
a) any residue \mathfrak{A}_P is an affine plane of order n ,
b) $|\mathcal{P}| = n^2 + n$, c) $|\mathcal{Z}| = n^3$.

4.3 Miquelian Laguerre-planes

4.3.1 The incidence structure $\mathfrak{L}(K)$

Unlike the Moebius-planes the formal generalization of the classical model of a Laguerre-plane, i.e. replacing \mathbb{R} by an arbitrary field, leads in any case to an example of a Laguerre-plane.

Let be K a field and

$$\mathcal{P} := (K \cup \{\infty\}) \times K = K^2 \cup (\{\infty\} \times K), \quad \infty \notin K,$$

$$\mathcal{Z} := \{(x, y) \in K^2 \mid y = ax^2 + bx + c\} \cup \{(\infty, a) \mid a, b, c \in K\}$$

and $\mathfrak{L}(K) := (\mathcal{P}, \mathcal{Z}, \in)$.

In order to show that in deed $\mathfrak{L}(K)$ is a Laguerre-plane, we first look for automorphisms.

4.3.2 Automorphisms of $\mathfrak{L}(K)$, $\mathfrak{L}(K)$ is a Laguerre-plane

Lemma 4.7 *The following mappings of \mathcal{P} onto itself are automorphisms of $\mathfrak{L}(K)$.*

$$\begin{aligned}
(1) : & \begin{cases} (x, y) & \rightarrow (sx, ty), & x \neq \infty \\ (\infty, a) & \rightarrow (\infty, \frac{t}{s^2}a) \end{cases} & 0 \neq s, t \in K \\
(2) : & \begin{cases} (x, y) & \rightarrow (x + s, y + t), & x \neq \infty \\ (\infty, a) & \rightarrow (\infty, a) \end{cases} & s, t \in K \\
(3) : & \begin{cases} (x, y) & \rightarrow (x, y + sx), & x \neq \infty \\ (\infty, a) & \rightarrow (\infty, a) \end{cases} & s \in K \\
(4) : & \begin{cases} (x, y) & \rightarrow (x, y + sx^2), & x \neq \infty \\ (\infty, a) & \rightarrow (\infty, a + s) \end{cases} & s \in K \\
(5) : & \begin{cases} (x, y) & \rightarrow (\frac{1}{x}, \frac{y}{x^2}), & x \neq 0, \infty \\ (0, y) & \rightarrow (\infty, y) \\ (\infty, a) & \rightarrow (0, a) \end{cases} \\
(6) : & \begin{cases} (x, y) & \rightarrow (\alpha(x), \alpha(y)), & x \neq \infty \\ (\infty, a) & \rightarrow (\infty, \alpha(a)) \end{cases} & \alpha : \text{automorphism of } K
\end{aligned}$$

From Lemma 4.7 we get

Lemma 4.8 *The automorphism group of the Laguerre-plane $\mathfrak{L}(K)$ operates transitively on*

- a) *the set of triples of points which are pairwise not parallel,*
- b) *the set of cycles.*

Especially the automorphism group operates transitively on the set of points. Hence, using Theorem 4.4 one has to check that $\mathfrak{A}_{(\infty,0)}$ is an affine plane which is obviously true.

Theorem 4.9 *$\mathfrak{L}(K)$ is a Laguerre-plane with the following parallel relation: $(a_1, a_2) \parallel (b_1, b_2)$ if and only if $a_1 = b_1$.*

Remark 4.1 *The automorphisms (1), (2), (3), and (6) from Lemma 4.7 induce collineations (dilatations and semilinear mappings) of the residue $\mathfrak{A}_{(\infty,0)}$ which fix the set of generators. The automorphism (5) induces in residue $\mathfrak{A}_{(1,0)}$ a reflection at line $x = -1$ if $\text{Char}K \neq 2$ and a translation if $\text{Char}K = 2$.*

Theorem 4.10 *The automorphisms of Lemma 4.7 generate the complete automorphism group of $\mathfrak{L}(K)$.*

Proof: Let be ψ an arbitrary automorphism of $\mathfrak{L}(K)$. Because of Lemma 4.8 there exists an automorphism μ generated by automorphisms (1)–(6) of Lemma 4.7 such that $\mu\psi$ fixes point $(\infty, 0)$. $\mu\psi$ induces in $\mathfrak{A}_{(\infty,0)}$ a collineation which fixes the point at infinity of the y-axis. Hence on K^2 the automorphism $\mu\psi$ has the form $(x, y) \rightarrow (s + u\alpha(x), t + v\alpha(x) + w\alpha(y))$ with $s, t, u, v, w, \in K$ and α is an automorphism of field K (see [DE,PR'76], Satz 3.13). Using Lemma 4.7 we find an automorphism δ such that $\delta\mu\psi$ is the identity. Hence ψ is already contained in the group generated by automorphisms (1)–(6). \square

4.3.3 Parabolic measure for angles in $\mathfrak{A}(K)$

In order to prove the Theorem of MIQUEL for Laguerre-planes in an analog manner as for Moebius-planes we introduce a suitable measure for angles between lines with equations $y = mx + c$.

Definition 4.5 For two lines $g_1 : y = m_1x + c_1$, $g_2 : y = m_2x + c_2$ of affine plane $\mathfrak{A}(K)$ the ordered pair $[g_1, g_2]$ is called **angle** and $\angle(g_1, g_2) = m_1 - m_2$ the **measure of angle** $[g_1, g_2]$.

Definition 4.6 For any three non parallel points $P_i = (x_i, y_i)$, $i = 1, 2, 3$, i.e. $x_1 \neq x_2 \neq x_3 \neq x_1$, we set $\angle(P_1, P_2, P_3) := \frac{y_2 - y_1}{x_2 - x_1} - \frac{y_2 - y_3}{x_2 - x_3}$.

With this definition we prove the **Theorem of inscribed angle for parabolas**.

Theorem 4.11 (4 points on a parabola) Four pairwise not parallel points $P_i = (x_i, y_i)$, $i = 1, 2, 3, 4$, lie on a parabola $y = ax^2 + bx + c$, $a \neq 0$ if and only if $\angle(P_1, P_3, P_2) = \angle(P_1, P_4, P_2)$.

Proof: I) If P_1, P_2, P_3, P_4 are on a parabola $y = ax^2 + bx + c$ then

$$\angle(P_1, P_3, P_2) = \frac{a(x_3^2 - x_1^2) + b(x_3 - x_1)}{x_3 - x_1} - \frac{a(x_3^2 - x_2^2) + b(x_3 - x_2)}{x_3 - x_2} = a(x_1 - x_2)$$

and analogously $\angle(P_1, P_4, P_2) = a(x_1 - x_2)$.

Hence $\angle(P_1, P_3, P_2) = \angle(P_1, P_4, P_2)$.

II) For four pairwise not parallel points P_1, P_2, P_3 and $P = (x, y)$ we assume $\angle(P_1, P_3, P_2) = \angle(P_1, P, P_2)$, i.e. $\frac{y_3 - y_1}{x_3 - x_1} - \frac{y_3 - y_2}{x_3 - x_2} = \frac{y - y_1}{x - x_1} - \frac{y - y_2}{x - x_2}$ which is the “3-point-form” of a parabola and hence equivalent to an equation $y = ax^2 + bx + c$ for suitable a, b, c . \square

4.3.4 Theorem of MIQUEL in $\mathfrak{L}(K)$

With the aid of Theorem 4.11 we shall proof the Theorem of MIQUEL and a degeneration of it for a Laguerre-plane $\mathfrak{L}(K)$.

Theorem 4.12 (Theorem of MIQUEL) For the Laguerre-plane $\mathfrak{L}(K)$ the following is true:

If for any 8 pairwise not parallel points P_1, \dots, P_8 which can be assigned to the vertices of a cube such that the points in 5 faces correspond to concyclical quadruples than the sixth quadruple of points is concyclical, too.

(For a better overview in figure 4.2 there are circles drawn instead of parabolas)

Proof: Because of the transitivity of the automorphism group of $\mathfrak{L}(K)$ we shall confine on the case $P_8 = (\infty, 0)$. Let be $P_i = (x_i, y_i)$ for $i = 1, \dots, 7$ with pairwise different x_i . Using the abbreviation $m_{ij} = \frac{y_i - y_j}{x_i - x_j}$ we get from Theorem 4.11 (see Fig. 4.3):

$m_{65} - m_{45} = m_{67} - m_{47}$, $m_{45} - m_{25} = m_{43} - m_{23}$ and, because of collinearity (see

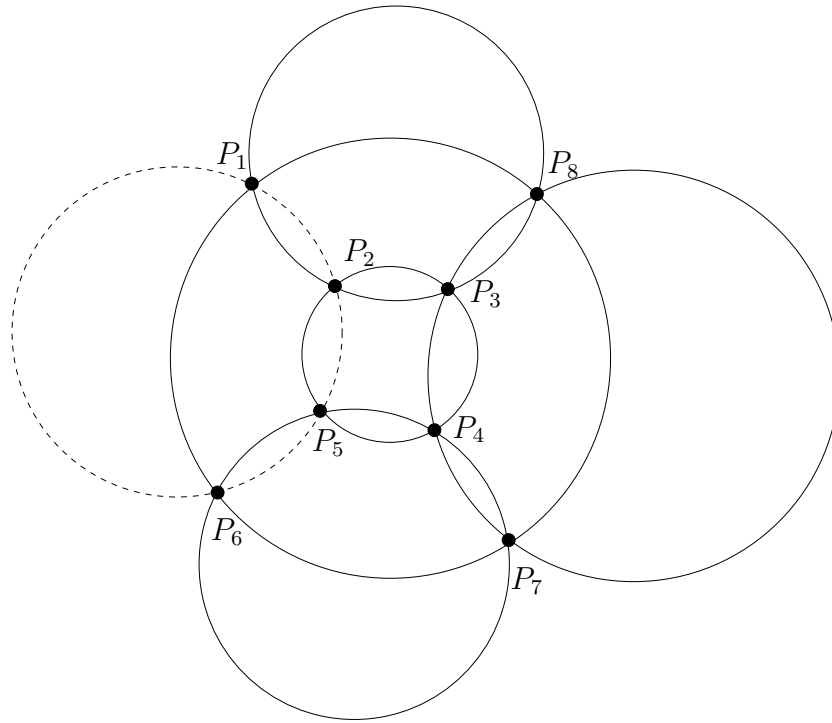

Figure 4.2: Theorem of Miquel for Laguerre-plane $\mathfrak{L}(K)$

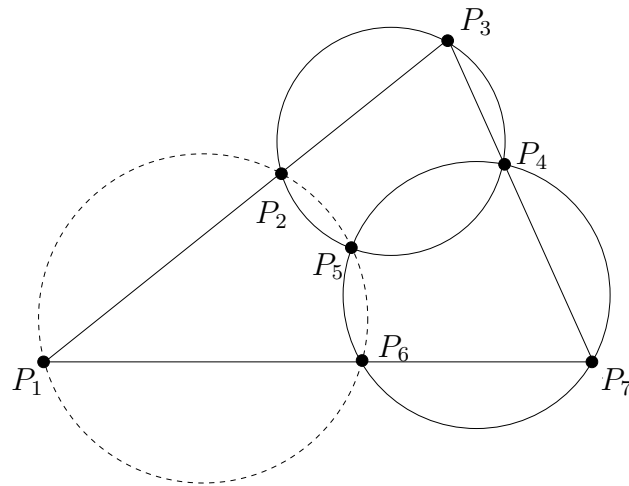

Figure 4.3: Proof of theorem of Miquel for Laguerre-plane $\mathfrak{L}(K)$

Fig.4.3),

$m_{16} = m_{67}$, $m_{43} = m_{47}$, $m_{12} = m_{23}$. Combining these equations leads to:

$$m_{65} - m_{25} = m_{45} + m_{67} - m_{47} - m_{25} = m_{25} + m_{43} - m_{23} + m_{67} - m_{47} - m_{25} = m_{61} - m_{21}.$$

With Theorem 4.11 we conclude: P_1, P_2, P_5, P_6 lie on a common cycle. \square

The performance of the proof was literally the same as the proof of the Theorem of MIQUEL for Moebius-planes. The same is true for the following 7-point-degeneration of the Theorem of MIQUEL.

Theorem 4.13 (7 point MIQUEL) *In case of $P_4 = P_5$ Theorem 4.12 is still true.*

The importance of these Theorems was recognized by v.d. WAERDEN:

Result 4.14 (v.d. WAERDEN & SMID, [WA,SM'35]) *A Laguerre-plane \mathfrak{L} satisfies the Theorem of MIQUEL and its 7-point-version if and only if \mathfrak{L} is isomorphic to a Laguerre-plane $\mathfrak{L}(K)$.*

Result 4.15 (CHEN, [CH'70]) *Result 3.22 is still true if one presumes the validity of the Theorem of MIQUEL without the 7-point-version.*

Because of these results we call a Laguerre-plane **miquelian** if it is isomorphic to a Laguerre-plane $\mathfrak{L}(K)$.

Remark 4.2 *The minimal model of a Laguerre-plane is miquelian. It is isomorphic to $\mathfrak{L}(K)$ with $K = GF(2)$.*

The following result is a consequence of the Theorem of SEGRE (Theorem 2.27) on ovals in desarguesian planes of odd order.

Result 4.16 (CHEN, KAERLEIN [CH,KA'73]) *A finite Laguerre-plane of odd order is miquelian if and only if there exists a desarguesian residue.*

4.4 Ovoidal Laguerre-planes

The classical real model of a Laguerre-plane can be described as the geometry of plane sections of a circular cylinder in 3-dimensional space (see [BE'73]). As an isomorphism between both models one can choose a suitable “stereographic projection” (alike for Moebius-planes). We shall introduce the isomorphism for *ovoidal* Laguerre-planes in general. But first we define an ovoidal Laguerre-plane which is a generalization of the classical cylinder model.

4.4.1 Definition of an ovoidal Laguerre-plane

Let be \mathfrak{P} a projective 3-space (not necessary pappian), ε_0 a plane of \mathfrak{P} , \mathfrak{o} an oval in ε_0 , R a point of \mathfrak{P} with $R \notin \varepsilon_0$ and

$\mathcal{P} := \bigcup_{X \in \mathfrak{o}} \overline{RX} \setminus \{R\}$ the set of **points**,

$\mathcal{Z} := \{\varepsilon \cap \mathcal{P} \mid \varepsilon \text{ plane of } \mathfrak{P}, R \notin \varepsilon\}$ the set of **cycles** and $\mathfrak{L}(\mathfrak{o}) := (\mathcal{P}, \mathcal{Z}, \in)$.

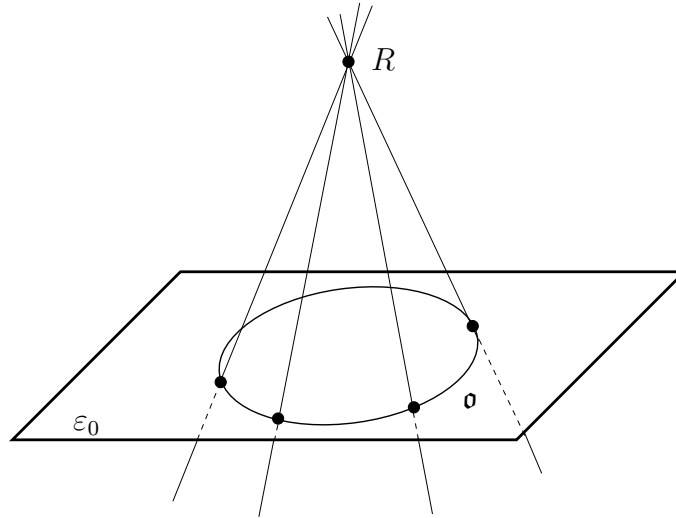

Figure 4.4: Ovoidal Laguerre-plane

Theorem 4.17 $\mathfrak{L}(\mathfrak{o})$ is a Laguerre-plane.

Proof: It is easy to check B1, B2 and B4.

To B3: Any cycle z is an oval of the plane containing z . Two cycles z_1, z_2 touch each other at a point P if and only if the intersection line of the corresponding planes ε_1 and ε_2 is a tangent line of the ovals z_1, z_2 . With the aid of this statement one proves B3. \square

Definition 4.7 A Laguerre-plane \mathfrak{L} is called **ovoidal** if it is isomorphic to a Laguerre-plane $\mathfrak{L}(\mathfrak{o})$.

For investigations on ovoidal Laguerre-planes the following plane model is advantageous.

4.4.2 The plane model of an ovoidal Laguerre-plane

Let be $\mathfrak{L}(\mathfrak{o})$ the space model (see previous section) of an ovoidal Laguerre-plane. We coordinatize the projective space \mathfrak{P} by homogeneous coordinates over a skewfield K with the following properties:

- 1) The 1-dimensional subspaces $\langle (x_1, x_2, x_3, x_4) \rangle$ of K^4 are the points of \mathfrak{P} .
- 2) Planes of \mathfrak{P} are described by equations of the form $ax_1 + bx_2 + cx_3 + dx_4 = 0$.
- 3) ε_0 is the plane $x_4 = 0$.
- 4) $\mathfrak{o} = \{ \langle (x, f(x), 1, 0) \rangle \mid x \in K \} \cup \{ \langle (0, 1, 0, 0) \rangle \}$ with a suitable function f of K into itself.
(If K is commutative and $f(x) = x^2$ then \mathfrak{o} is an oval conic.)
The line with $x_3 = x_4 = 0$ is tangent to \mathfrak{o} at point $T := \langle (0, 1, 0, 0) \rangle$.
- 5) The “vertex” of the cone is $R = \langle (0, 1, 0, 1) \rangle \notin \varepsilon_0$.

Hence

$$\begin{aligned} \mathcal{P} &= \{ \langle (x, f(x) + s, 1, s) \rangle \mid x, s \in K \} \cup \{ \langle (0, 1 + t, 0, t) \rangle \mid t \in K \} \\ &= \{ \langle (x, y, 1, y - f(x)) \rangle \mid x, y \in K \} \cup \{ \langle (0, 1 + t, 0, t) \rangle \mid t \in K \}. \end{aligned}$$

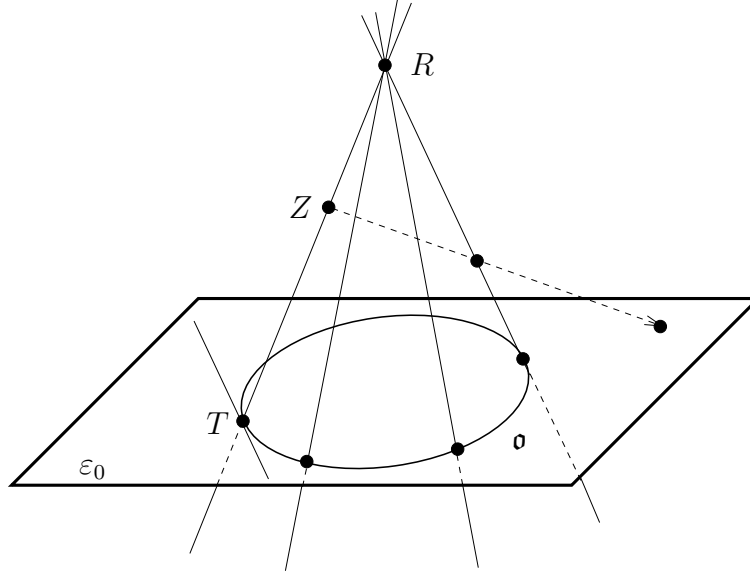

Figure 4.5: Plane model of an ovoidal Laguerre-plane

An arbitrary plane ε with $R \notin \varepsilon$ has an equation $ax_1 + bx_2 + cx_3 + dx_4 = 0$ with $b + d = 1$ and

$$\varepsilon \cap \mathcal{P} = \{ \langle (x, y, 1, y - f(x)) \rangle \mid x, y \in K, y = df(x) - ax - c \} \cup \{ \langle (0, d, 0, d - 1) \rangle \}.$$

The “stereographic projection”

$$\psi : \begin{cases} \mathcal{P} & \rightarrow K^2 \cup (\{\infty\} \times K), \\ \langle (x, y, 1, y - f(x)) \rangle & \rightarrow (x, y) \\ \langle (0, d, 0, d - 1) \rangle & \rightarrow (\infty, d) \end{cases}$$

is a bijection and maps a cycle $\varepsilon \cap \mathcal{P}$ onto a set of points $\{(x, y) \mid y = df(x) - ax - c\} \cup \{(\infty, d)\}$.

(The effect of ψ on $\mathcal{P} \setminus \overline{RT}$ can be considered as the projection with center $Z := \langle (0, 0, 0, -1) \rangle \in \overline{RT}$ onto the affine plane $\varepsilon_0 : \{ \langle (x, y, 1, 0) \rangle \mid x, y \in K \}$.)

The result of this considerations is

Theorem 4.18 *A Laguerre-plane \mathfrak{L} is ovoidal if and only if there exists a skewfield K and a function $f : K \rightarrow K$ such that \mathfrak{L} is isomorphic to $\mathfrak{L}(K, f) := (\mathcal{P}, \mathcal{Z}, \varepsilon)$ with*

$$\mathcal{P} := (K \cup \{\infty\}) \times K = K^2 \cup (\{\infty\} \times K), \quad \infty \notin K,$$

$$\mathcal{Z} := \{ \{(x, y) \in K^2 \mid y = af(x) + bx + c\} \cup \{(\infty, a)\} \mid a, b, c \in K \}$$

and

$\circ := \{(x, y) \in K^2 \mid y = f(x)\} \cup \{(\infty)\}$ is an oval of the projective plane $\mathfrak{P}(K)$ (see

Chapter 1).

Remark 4.3 a) Function f can be “normalized” such that $f(0) = 0, f(1) = 1$ and the x -axis is a tangent line to \mathfrak{o} .

b) Any residue of an ovoidal Laguerre-plane is desarguesian.

4.4.3 Examples of ovoidal Laguerre-planes

For any oval \mathfrak{o} of a desarguesian projective plane we get a Laguerre-plane $\mathfrak{L}(\mathfrak{o})$. Many ovoidal Laguerre-planes have rather simple representations using the plane model:

- 1) An ovoidal Laguerre-plane $\mathfrak{L}(K, f)$ with a normalized function f is miquelian if and only if K is commutative and $f(x) = x^2$. Hence an ovoidal Laguerre-plane $\mathfrak{L}(\mathfrak{o})$ is miquelian if and only if \mathfrak{P} is pappian and \mathfrak{o} is an oval conic.
- 2) a) For $K = \mathbb{R}$ and $f(x) = x^4$ the incidence structure $\mathfrak{L}(K, f)$ is an ovoidal Laguerre-plane.
b) For $K = \mathbb{R}$ and $f(x) = \cosh x$ the incidence structure $\mathfrak{L}(K, f)$ is an ovoidal Laguerre-plane.
- 3) For $K = GF(2^n), f(x) = x^{(2^k)}$ with $k \in \{1, 2, \dots, n-1\}$ and k and n have no common divisor the incidence structure $\mathfrak{L}(K, f)$ is an ovoidal Laguerre-plane over a *translation oval* (see Section 2.7.1).
- 4) In case of “ K skewfield, $Char K = 2$ ” and f is an injective function on K with $f(0) = 0, f(1) = 1$ which fulfills the functional equations
(i): $f(x_1 + x_2) = f(x_1) + f(x_2),$ (ii): $f(xf(x)^{-1}) = f(x)^{-1}, x \neq 0$
the incidence structure $\mathfrak{L}(K, f)$ is an ovoidal Laguerre-plane over a *Moufang oval* (see Section 2.7.2).

Remark 4.4 In case of $K = GF(2^n), n \geq 3$, the system $\mathfrak{K} := \{(x, y) \in K^2 \mid y = ax^2 + bx + c \mid a, b, c \in K\}$ of curves can be embedded into two different (non isomorphic) Laguerre-planes:

$$\mathcal{P} := K^2 \cup (\{\infty\} \times K), \quad \infty \notin K,$$

$$\mathcal{Z}_1 := \{(x, y) \in K^2 \mid y = ax^2 + bx + c\} \cup \{(\infty, a) \mid a, b, c \in K\}$$

$$\mathcal{Z}_2 := \{(x, y) \in K^2 \mid y = ax^2 + bx + c\} \cup \{(\infty, b) \mid a, b, c \in K\}$$

$\mathfrak{L}_1 := (\mathcal{P}, \mathcal{Z}_1, \in)$ is the miquelian Laguerre-plane over K .

$\mathfrak{L}_2 := (\mathcal{P}, \mathcal{Z}_2, \in)$ is isomorphic to example 3) with $k = n - 1$. (The mapping $(x, y) \rightarrow (x^{(2^{n-1})}, y)$ is the corresponding isomorphism.)

4.4.4 Automorphisms of an ovoidal Laguerre-plane $\mathfrak{L}(K, f)$

One easily checks the validity of

Lemma 4.19 *Let be $\mathfrak{L}(K, f) = (\mathcal{P}, \mathcal{Z}, \in)$ defined as in Theorem 4.18. The following mappings are automorphisms of $\mathfrak{L}(K, f)$:*

$$\begin{aligned}
 (1) : & \begin{cases} (x, y) & \rightarrow (x, y + s), & x \neq \infty \\ (\infty, a) & \rightarrow (\infty, a) \end{cases} & , s \in K & \quad (\text{translation in } \mathfrak{A}_{(\infty, 0)}) \\
 (2) : & \begin{cases} (x, y) & \rightarrow (x, y + sx), & x \neq \infty \\ (\infty, a) & \rightarrow (\infty, a) \end{cases} & , s \in K & \quad (\text{shear in } \mathfrak{A}_{(\infty, 0)}) \\
 (3) : & \begin{cases} (x, y) & \rightarrow (x, sy), & x \neq \infty \\ (\infty, a) & \rightarrow (\infty, sa) \end{cases} & , s \in K \setminus \{0\} & \quad (\text{dilatation in } \mathfrak{A}_{(\infty, 0)}) \\
 (4) : & \begin{cases} (x, y) & \rightarrow (x, y + sf(x)), & x \neq \infty \\ (\infty, a) & \rightarrow (\infty, a + s) \end{cases} & , s \in K & \quad (\text{translation in } \mathfrak{A}_{(0, 0)})
 \end{aligned}$$

Remark 4.5 a) (1) and (4) have exactly one generator as set of fixed points if $s \neq 0$.

b) (2) has exactly two generators as set of fixed points if $s \neq 0$.

c) (3) has exactly one cycle as set of fixed points if $s \neq 1$.

From Lemma 4.19 we get

Theorem 4.20 *The automorphism group of an ovoidal Laguerre-plane operates transitively on the set of cycles.*

Further statements on the automorphisms of an ovoidal Laguerre-plane are contained in Section 4.6.

4.4.5 The bundle theorem for Laguerre-planes

Similar to ovoidal Moebius-planes the ovoidal Laguerre-planes can be characterized by the *Bundle Theorem*:

Theorem 4.21 (Bundle Theorem) *For an ovoidal Laguerre-plane \mathfrak{L} the following statement holds:*

Let be $A_1, A_2, A_3, A_4, B_1, B_2, B_3, B_4$ eight pairwise non parallel points. If 5 of the six quadruples $Q_{ij} := \{A_i, B_i, A_j, B_j\}$, $i < j$, are concyclical on at least 4 cycles k_{ij} then this is true for the last quadruple, too (see Theorem 3.25).

Proof: Analogously to the Bundle Theorem for Moebius-planes (Theorem 3.25).

Result 4.22 (KAHN, [KH'80]) *A Laguerre-plane is ovoidal if and only if the Bundle Theorem (Theorem 4.21) holds.*

A further characterization will be given in Section 4.6.

Remark 4.6 *Any Moebius-plane of even order is ovoidal and any Minkowski-plane of even order is miquelian. An analog statement for Laguerre-planes of even order is still unknown.*

4.5 Non ovoidal Laguerre-planes

The first non ovoidal Laguerre-planes were presented by MÄURER in [MÄ'72]. They are isomorphic to Examples 1:

Example 4.1 (MÄURER [MÄ'72], HARTMANN [HA'76])

Let be $k \in \mathbb{R}$ with $0 < k \neq 1$, $a \circ b := \begin{cases} kab & , \text{ if } a, b < 0 \\ ab & , \text{ other cases} \end{cases}$.

and $\mathcal{P} := \mathbb{R}^2 \cup (\{\infty\} \times \mathbb{R})$, $\infty \notin \mathbb{R}$,

$\mathcal{Z}_1 := \{(x, y) \in \mathbb{R}^2 \mid y = a \circ x \circ x + b \circ x + c\} \cup \{(\infty, a)\} \mid a, b, c \in \mathbb{R}\}$.

Then $\mathfrak{L}_1 := (\mathcal{P}, \mathcal{Z}_1, \in)$ is a Laguerre-plane. The residue $\mathfrak{A}_{(\infty, 0)}$ is an affine MOULTON plane. Hence \mathfrak{L}_1 is not ovoidal (see Remark b) to Theorem 4.18).

Example 4.2 (HARTMANN [HA'79a])

Let be $r_1, r_2 \in \mathbb{R}$ with $r_1, r_2 > 1$, f the function on \mathbb{R} with $f(x) := \begin{cases} x^{r_1} & \text{for } x \geq 0 \\ x^{r_2} & \text{for } x < 0 \end{cases}$

and

$\mathcal{P} := \mathbb{R}^2 \cup (\{\infty\} \times \mathbb{R})$, $\infty \notin \mathbb{R}$,

$\mathcal{Z}_2 := \{(x, y) \in \mathbb{R}^2 \mid y = mx + d\} \cup \{(\infty, 0)\} \mid m, d \in \mathbb{R}\}$

$\cup \{(x, y) \in \mathbb{R}^2 \mid y = af(x - b) + c\} \cup \{(\infty, a)\} \mid a, b, c \in \mathbb{R}, a \neq 0\}$.

Then $\mathfrak{L}_2 := (\mathcal{P}, \mathcal{Z}_2, \in)$ is a Laguerre-plane.

For $r_1 = r_2 = 2$ \mathfrak{L}_2 is the classical real Laguerre-plane.

For any other case \mathfrak{L}_2 is non ovoidal because there are desarguesian and non desarguesian residues.

Example 4.3 (GROH [GR'74c])

Let be $\mathfrak{M} = (\mathcal{P}_M, \mathcal{Z}_M, \in)$ a non ovoidal Moebius-plane as defined in Section 3.5 and

$\mathcal{P} :=$ set of oriented lines of affine plane $\mathfrak{A}(\mathbb{R})$,

$\mathcal{Z} := \mathbb{R}^2 \cup \{\text{oriented cycles } \in \mathcal{Z}_M \text{ which not contain } \infty\}$

Incidence I is defined as follows:

For any line g of $\mathfrak{A}(\mathbb{R})$ we have two oriented lines $g_1, g_2 \in \mathcal{P}$. Analogously we get for any circle $k \in \mathcal{Z}_M$ two oriented circles $k_1, k_2 \in \mathcal{Z}$.

$g_i \in \mathcal{P}$, $(x, y) \in \mathbb{R}^2$: $g_i I(x, y) \leftrightarrow (x, y) \in g$

$g_i \in \mathcal{P}$, $k_j \in \mathcal{Z} \setminus \mathbb{R}^2$: $g_i I k_j \leftrightarrow |g \cap k| = 1$ and orientations at touching point are the same

$\mathfrak{L} := (\mathcal{P}, \mathcal{Z}, I)$ is a Laguerre-plane.

If \mathfrak{M} is the classical real Moebius-plane then \mathfrak{L} is the original model of the classical real Laguerre-plane (see [BE'73]).

For "most" cases \mathfrak{L} is non ovoidal (see [GR'74c]).

Example 4.4 (*HARTMANN [HA'82b]*)

[HA'82b] contains non ovoidal examples over alternative division rings of characteristic 2.

4.6 Automorphisms of Laguerre-planes

The close connection between a Laguerre-plane and affine planes (the residues are affine planes !) motivates to look for automorphisms with at least one fixpoint. Such automorphisms induce collineations of the residue at a fixpoint. In order to use results on the coordinatization of affine planes we focus on automorphisms which induce translations, dilatations or shears in the residue of a fixpoint.

Definition 4.8 Let $\mathfrak{L} = (\mathcal{P}, \mathcal{Z}, \in)$ be a Laguerre-plane.

- a) An automorphism that fixes two non parallel points P, Q and any cycle containing P, Q is called **dilatation at P, Q** .
Abbreviation for the group of dilatations: $\Delta(P, Q)$.
- b) An automorphism that fixes a point P , any point of a generator e and a cycle z containing P is called **dilatation at P, e with direction z** .
Group: $\Delta(P, e; z)$.
- c) An automorphism that fixes the points of two generators e_1, e_2 and any generator is called **shear at e_1, e_2** .
Group: $\Sigma(e_1, e_2)$.
- d) An automorphism that fixes exactly the points of one generator e or \mathcal{P} and any generator is called **translation with axis e in direction \mathfrak{E}** . (\mathfrak{E} is the set of generators.)
Group: $T(e, \mathfrak{E})$.
- e) An automorphism that fixes exactly the points of a generator e or \mathcal{P} and a cycle z is called **translation with axis e in direction z** .
Group: $T(e, z)$.
- f) An automorphism that fixes any point of a cycle z is called **dilatation at z** .
Group: $\Delta(z)$.

Obviously the following is true

Lemma 4.23 a) Any dilatation at P, Q induces a dilatation in \mathfrak{A}_P at point Q .

- b) Any dilatation at a point P , a generator e in direction z (containing P) induces a dilatation at line e in \mathfrak{A}_P .
- c) A shear at two generators e_1, e_2 induces a shear in any residue $\mathfrak{A}_P, P \in e_1 \cup e_2$.
- d) Any translation with axis e and \mathfrak{E} -direction induces a translation in any residue $\mathfrak{A}_P, P \in e$.

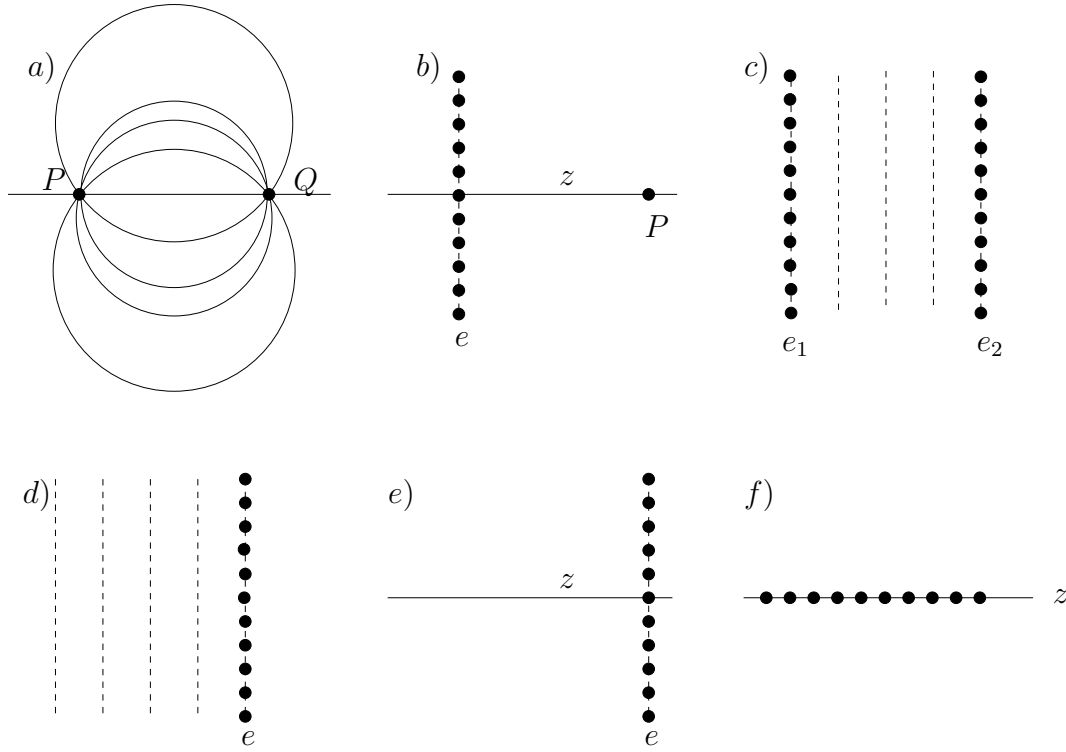

Figure 4.6: Automorphisms a)–f) of a Laguerre-plane

- e) Any translation with axis e in z -direction induces a translation in $\mathfrak{A}_P, \{P\} = e \cap z$.
- f) Any dilatation at a cycle z induces a dilatation at a line in any residue $\mathfrak{A}_P, P \in z$.

Definition 4.9 *ab) Groups $\Delta(P, Q)$ and $\Delta(P, e; z)$ are called **circular transitive** if their restriction onto \mathfrak{A}_P is linear transitive.*

*c) Group $\Sigma(e_1, e_2)$ is called **circular transitive** if their restriction onto $\mathfrak{A}_P, P \in e_1 \cup e_2$ is linear transitive.*

*d) Group $T(e, \mathfrak{E})$ is called **circular transitive** if their restriction onto $\mathfrak{A}_P, P \in e$ is linear transitive.*

*e) Group $T(e, z)$ is called **circular transitive** if their restriction onto $\mathfrak{A}_P, \{P\} = e \cap z$ is linear transitive.*

*f) Group $\Delta(z)$ is called **circular transitive** if their restriction onto $\mathfrak{A}_P, P \in z$ is linear transitive.*

Lemma 4.24 *Let be \mathfrak{L} a Laguerre-plane, $\bar{\sigma}$ an automorphism of \mathfrak{L} with fixpoint P such that the restriction onto \mathfrak{A}_P is a shear at a line $e \in \mathfrak{E}$ (generator not containing P). Then $\bar{\sigma}$ is a shear of \mathfrak{L} at the generators \bar{P}, e . (Hence any point parallel to P is fixed.)*

Proof: If $\bar{\sigma}$ fixes any point of the generator $e \neq \bar{P}$ and if $Q \in e$ then σ induces in \mathfrak{A}_Q a collineation σ_Q which fixes any generator. If σ_Q is not the identity the set of fixpoints is at least P and at most \bar{P} . Hence σ_Q is a shear in \mathfrak{A}_Q and $\bar{\sigma}$ a shear at e, \bar{P} in \mathfrak{L} . \square

It is unknown if Lemma 4.24 is true for translations, too.

Using additional assumptions a similar result can be achieved:

Lemma 4.25 *Let be \mathfrak{L} a Laguerre-plane, $\bar{\tau}$ an automorphism of \mathfrak{L} with fixpoint P such that the restriction onto \mathfrak{A}_P is a translation. Then $\bar{\tau}$ is a translation of \mathfrak{L} . (Hence any point parallel to P is fixed.) if one of the following conditions is fulfilled:*

- a) *There is a point $Q \notin \bar{P}$ such that $\Delta(P, Q)$ is circular transitive.*
- b) *\mathfrak{A}_P is a translation plane of characteristic $\neq 2$ and any reflection at a point (in \mathfrak{A}_P) is induced by a dilatation (of \mathfrak{L}) at a pair of points.*
- c) *\mathfrak{L} is finite and $\bar{\tau}$ involutorial.*
- d) *\mathfrak{L} is ovoidal of characteristic 2.*

Proof: see [HA'82b], Lemma 2.2.

Definition 4.10 *Let be \mathfrak{L} a Laguerre-plane, $\bar{\sigma}$ an involutorial automorphism*

- a) *with two fixpoints P, Q . Then $\bar{\sigma}$ is called **reflection at P, Q** .*
- b) *whose set of fixpoints consists of two generators $e_1 \neq e_2$ and which leaves one cycle invariant is called **reflection at e_1, e_2** .*
- c) *whose fixpoints are the points of a cycle z is called **reflection at z** .*

For involutorial automorphisms the following statements hold:

Lemma 4.26 a) *A reflection $\bar{\sigma}_{PQ}$ at two non parallel points P, Q is a dilatation at P, Q .*

- b) *An involutorial dilatation $\bar{\sigma} \in \Delta(P, e; z)$ is a reflection at the generators e, \bar{P} .*
- c) *An involutorial dilatation $\bar{\tau}$ whose set of fixpoints are the points of a generator e is a translation (of \mathfrak{L}) with axis e .*
- d) *An involutorial automorphism $\bar{\sigma}$ whose set of fixpoints are the points of two generators $e_1 \neq e_2$ is a reflection at e_1, e_2 or a shear at e_1, e_2 .*

Proof: see [HA'82b], Lemma 2.3.

4.6.1 Transitivity properties of ovoidal Laguerre-planes

Theorem 4.27 *For an ovoidal Laguerre-plane the following statements are true:*

- a) *Any group $T(e; \mathfrak{E})$ of translations in \mathfrak{E} -direction is circular transitive.*
- b) *Any group $\Sigma(e_1, e_2)$ of shears is circular transitive.*
- b) *Any group $\Delta(z)$ of dilatations is circular transitive.*
- d) *In case of characteristic $\neq 2$ for any cycle there is a reflection.*

Proof: The statements can be checked easily using the plane model of an ovoidal Laguerre-plane and Lemma 4.19. \square

For a *miquelian* Laguerre-plane we get additionally

Theorem 4.28 *For a miquelian Laguerre-plane the following statements are true:*

- a) *Any group $\Delta(P, Q)$ of dilatations at pairs of points is circular transitive.*
- b) *Any group $\Delta(P, e; z)$ of dilatations at generators is circular transitive.*
- c) *Any group $T(e; z)$ of translations is circular transitive.*
- d) *In case of characteristic $\neq 2$ for any pair of non parallel points there is a reflection.*
- e) *In case of characteristic $\neq 2$ for any pair of generators $e_1 \neq e_2$ and cycle z there is exactly one reflection at e_1, e_2 which leaves z invariant.*

Proof: Use Lemma 4.7 and Lemma 4.8. \square

Theorem 4.29 *For an ovoidal Laguerre-plane over a Moufang oval any group $T(e; z)$ of translations in the direction of a cycle is circular transitive.*

Proof: Let be $\mathfrak{L}(K, f)$ an ovoidal Laguerre-plane as defined in Theorem 4.18 over a Moufang oval (see Section 4.4.3). From the property $f(x_1 + x_2) = f(x_1) + f(x_2)$ we get the circular transitivity of $T(e; z)$ for $(\infty, 0)$. The statement for other groups $T(e; z)$ yields can be achieved using the following mapping which is an automorphism of $\mathfrak{L}(K, f)$:

$$\begin{cases} (x, y) & \rightarrow (xf(x)^{-1}, yf(x)^{-1}), & x \neq 0 \\ (0, y) & \rightarrow (\infty, y) \\ (\infty, a) & \rightarrow (0, a) \end{cases}$$

(Take notice of the functional equation $f(xf(x)^{-1}) = f(x)^{-1}$ for $x \neq 0$.) \square

Theorem 4.30 *For a finite and ovoidal Laguerre-plane over a translation oval there exists a generator e_0 such that*

- a) *any translation group $T(e_0; z)$ is circular transitive,*
- b) *any dilatation group $\Delta(P, Q)$ with $P \in e_0$ is circular transitive,*

c) any dilatation group $\Delta(P, e; z)$ with $P \in e_0$ is circular transitive.

Proof: An ovoidal Laguerre-plane over a finite translation oval can be represented as $\mathfrak{L}(K, f)$ with $K = GF(2^n)$ and function $f(x) = x^{(2^k)}$ (see Section 4.4.3). We choose $e_0 = (\infty, 0)$.

To a): From the property $f(x_1 + x_2) = f(x_1) + f(x_2)$ we get the circular transitivity of any group $T(e_0; z)$.

To b): Because of a) and Theorem 4.27 it suffice to discuss the case with $P = (\infty, 0)$ and $Q = (0, 0)$. Obviously any mapping

$$\begin{cases} (x, y) & \rightarrow (sx, sy), s \neq 0 \\ (\infty, a) & \rightarrow (\infty, asf(s)^{-1}) \end{cases}$$

is an automorphism of $\mathfrak{L}(K, f)$ and $\Delta(P, Q)$ is circular transitive.

To c): Because of theorem 4.20 and statement a) we confine to the case with $P = (\infty, 0)$, e is generator $x = 0$ and z cycle $y = 0$. For this case it is simple to check the circular transitivity of $\Delta(P, e; z)$. \square

The following results use the properties above to characterize certain classes of ovoidal Laguerre-planes.

Result 4.31 (KREBS, MÄURER [MÄ'77], Satz 6) *A Laguerre-plane $\mathfrak{L} = (\mathcal{P}, \mathcal{Z}, \in)$ is miquelian if and only if any dilatation group $\Delta(z), z \in \mathcal{Z}$ is circular transitive.*

Result 4.32 (HARTMANN [HA'82b], Satz 7) *A Laguerre-plane $\mathfrak{L} = (\mathcal{P}, \mathcal{Z}, \in)$ is miquelian if and only if any dilatation group $\Delta(P, Q), P, Q \in \mathcal{P}$ is circular transitive.*

In case of characteristic $\neq 2$ we have stronger results:

Result 4.33 *A Laguerre-plane $\mathfrak{L} = (\mathcal{P}, \mathcal{Z}, \in)$ of characteristic $\neq 2$ is miquelian if and only if*

- a) *for any pair of non parallel points P, Q there is exactly one reflection at P, Q . (see MÄURER [MÄ'78])*
- b) *There is a generator e_0 such that any dilatation group $\Delta(P, Q), P \in e_0$ is circular transitive and contains an involution. (see HARTMANN [HA'82b], Satz 8)*
- c) *There is a generator e_0 such that any dilatation group $\Delta(P, e; z), P \in e_0$ is circular transitive and contains an involution. (see HARTMANN [HA'82b], Satz 10)*

Results 4.33 can not be extended to characteristic $\neq 2$:

Result 4.34 (HARTMANN [HA'82b], Satz 9, Satz 11) *A finite Laguerre-plane $\mathfrak{L} = (\mathcal{P}, \mathcal{Z}, \in)$ of even order is ovoidal over a translation oval if there is a generator e_0 such that one of the following statements hold:*

- a) *Any dilatation group $\Delta(P, Q), P \in e_0$ is circular transitive.*

b) Any dilatation group $\Delta(P, e; z)$, $P \in e_0$ is circular transitive.

Ovoidal Laguerre-planes over Moufang ovals can be characterized by translations:

Result 4.35 (HARTMANN [HA'82b], Satz 4) *A Laguerre-plane $\mathfrak{L} = (\mathcal{P}, \mathcal{Z}, \in)$ is ovoidal over a Moufang oval if*

- i) at least one residue is desarguesian of characteristic 2,*
- ii) any translation group $T(e; z)$ is circular transitive.*

Property *i)* of the last result is essential and can not be omitted. There are **non ovoidal** Laguerre-planes which fulfill property *ii)* (see [HA'82b], Remark to Satz 14). But for finite Laguerre-planes we have

Result 4.36 (HARTMANN [HA'82b], Satz 1) *A finite Laguerre-plane $\mathfrak{L} = (\mathcal{P}, \mathcal{Z}, \in)$ is miquelian if and only if any translation group $T(e; z)$ is circular transitive.*

Chapter 5

MINKOWSKI–PLANES

Literature: [BE'73]

5.1 The classical real Minkowski–plane

Applying the *pseudo-euclidean* distance $d_P(P_1, P_2) = (x_1 - x_2)^2 - (y_1 - y_2)^2$ on two points $P_i = (x_i, y_i)$ (instead of the euclidean one) we get the geometry of *hyperbolas*, because a *pseudoeuclidean circle* $\{P \in \mathbb{R}^2 \mid d_P(P, M) = r\}$ is a hyperbola with midpoint M . By a suitable coordinate transformation we can rewrite the pseudo-euclidean distance as $d'_P(P_1, P_2) = (x_1 - x_2)(y_1 - y_2)$. Now the hyperbolas have asymptotes parallel to the coordinate axes. The following completion (see Moebius– and Laguerre–planes) “homogenizes” the geometry of hyperbolas:

$\mathcal{P} := (\mathbb{R} \cup \{\infty\})^2 = \mathbb{R}^2 \cup (\{\infty\} \times \mathbb{R}) \cup (\mathbb{R} \times \{\infty\}) \cup \{(\infty, \infty)\}$, $\infty \notin \mathbb{R}$, the set of **points**,

$\mathcal{Z} := \{(x, y) \in \mathbb{R}^2 \mid y = ax + b\} \cup \{(\infty, \infty)\} \mid a, b \in \mathbb{R}, a \neq 0\}$
 $\cup \{(x, y) \in \mathbb{R}^2 \mid y = \frac{a}{x-b} + c, x \neq b\} \cup \{(b, \infty), (\infty, c)\} \mid a, b, c \in \mathbb{R}, a \neq 0\}$, the set of **cycles**.

The incidence structure $(\mathcal{P}, \mathcal{Z}, \in)$ is called **classical real Minkowski–plane**.

Remark 5.1 *One should not confuse the Minkowski–plane defined above with the Minkowski–plane founded on reflections (see [LI'78]).*

Obviously the set of cycles can be described by the group $PGL(2, \mathbb{R})$ operating on $\mathbb{R} \cup \{\infty\}$:

$$\mathcal{Z} = \{(x, y) \in \mathcal{P} \mid y = \pi(x)\} \mid \pi \in PGL(2, \mathbb{R})\}.$$

A cycle defined by equation $y = ax + b$ is represented by a permutation $\pi \in PGL(2, \mathbb{R})$ with $\pi(\infty) = \infty$ and a cycle defined by equation $y = \frac{a}{x-b} + c$ is represented by $\pi \in PGL(2, \mathbb{R})$ with $\pi(\infty) = c$ and $\pi(b) = \infty$.

Two points $(x_1, y_1) \neq (x_2, y_2)$ can not be connected by a cycle if and only if $x_1 = x_2$ or $y_1 = y_2$. Similar to the parallel relation for Laguerre–planes we define:

Two points P_1, P_2 are **(+)-parallel** ($P_1 \parallel_+ P_2$) if $x_1 = x_2$ and **(-)-parallel** ($P_1 \parallel_- P_2$) if $y_1 = y_2$. Both these relations are equivalence relations on the set of points.

Two points P_1, P_2 are called **parallel** ($P_1 \parallel P_2$) if $P_1 \parallel_+ P_2$ or $P_1 \parallel_- P_2$.

Lemma 5.1 *The mappings $(x, y) \rightarrow (y, x)$ and $(x, y) \rightarrow (\alpha(x), \beta(y)$, $\alpha, \beta \in PGL(2, \mathbb{R})$ are automorphisms of $(\mathcal{P}, \mathcal{Z}, \in)$ (see Section 5.3).*

With help of the last lemma we find:

- Lemma 5.2**
1. *For any pair of non parallel points A, B there is exactly one point C with $A \parallel_+ C \parallel_- B$.*
 2. *For any point P and any cycle z there are exactly two points $A, B \in z$ with $A \parallel_+ P \parallel_- B$.*
 3. *For any three points A, B, C , pairwise non parallel, there is exactly one cycle z which contains A, B, C .*
 4. *For any cycle z , any point $P \in z$ and any point $Q, P \not\parallel Q$ and $Q \notin z$ there exists exactly one cycle z' such that $z \cap z' = \{P\}$, i.e. z **touches** z' at point P .*

Like the classical Moebius- and Laguerre-planes Minkowski-planes can be described as the geometry of plane sections of a suitable quadric. But in this case the quadric lives in *projective* 3-space: The classical real Minkowski-plane is isomorphic to the geometry of plane sections of a *hyperboloid of one sheet* (not degenerated quadric of index 2). The isomorphism will be introduced in Section 5.3.

5.2 The axioms of a Minkowski-plane

Definition 5.1 *Let be $(\mathcal{P}, \mathcal{Z}; \parallel_+, \parallel_-, \in)$ an incidence structure with the set \mathcal{P} of points, the set \mathcal{Z} of cycles and two equivalence relations \parallel_+ ((+)-parallel) and \parallel_- ((-)-parallel) on set \mathcal{P} .*

For $P \in \mathcal{P}$ we define: $\overline{P}_+ := \{Q \in \mathcal{P} \mid Q \parallel_+ P\}$ and $\overline{P}_- := \{Q \in \mathcal{P} \mid Q \parallel_- P\}$.

*An equivalence class \overline{P}_+ or \overline{P}_- is called **(+)-generator** and **(-)-generator**, respectively. Furthermore we define: $\mathcal{E}^+ := \{\overline{P}_+ \mid P \in \mathcal{P}\}$, $\mathcal{E}^- := \{\overline{P}_- \mid P \in \mathcal{P}\}$ and $\mathcal{E} := \mathcal{E}^+ \cup \mathcal{E}^-$.*

*Two points A, B are called **parallel** ($A \parallel B$) if $A \parallel_+ B$ or $A \parallel_- B$.*

Definition 5.2 *An incidence structure $\mathfrak{M} := (\mathcal{P}, \mathcal{Z}; \parallel_+, \parallel_-, \in)$ is called **Minkowski-plane** if the following axioms hold:*

- C1: *For any pair of non parallel points A, B there is exactly one point C with $A \parallel_+ C \parallel_- B$.*
- C2: *For any point P and any cycle z there are exactly two points $A, B \in z$ with $A \parallel_+ P \parallel_- B$.*

C3: For any three points A, B, C , pairwise non parallel, there is exactly one cycle z which contains A, B, C .

C4: For any cycle z , any point $P \in z$ and any point $Q, P \not\parallel Q$ and $Q \notin z$ there exists exactly one cycle z' such that $z \cap z' = \{P\}$, i.e. z **touches** z' at point P .

C5: Any cycle contains at least 3 points. There is at least one cycle z and a point P not in z .

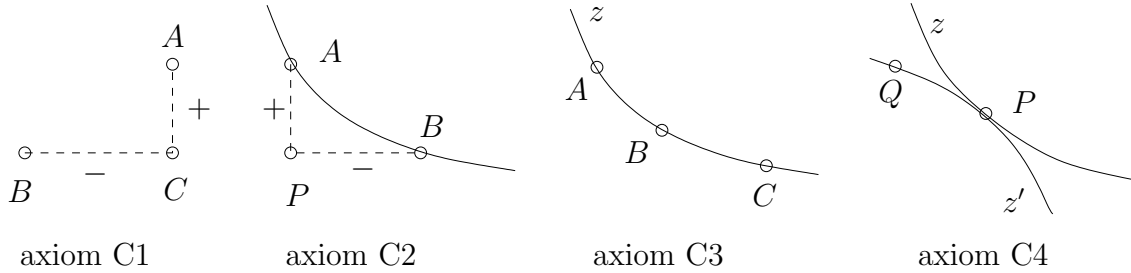

Figure 5.1: Axioms of a Minkowski-plane

For investigations the following statements on parallel classes (equivalent to C1, C2 respectively) are advantageous.

C1': For any two points A, B we have $|\overline{A}_+ \cap \overline{B}_-| = 1$.

C2': For any point P and any cycle z we have: $|\overline{P}_+ \cap z| = 1 = |\overline{P}_- \cap z|$.

First consequences of the axioms are

Lemma 5.3 For a Minkowski-plane \mathfrak{M} the following is true

- a) Any point is contained in at least one cycle.
- b) Any generator contains at least 3 points.
- c) Two points can be connected by a cycle if and only if they are non parallel.

Proof: a) For a point P on a cycle z statement a) is true. If P is a point and z any cycle not containing P then from C5 and C2 we find a point $Q \in z$ with $P \not\parallel Q$. Because of C4 there is a cycle z' containing P and Q .

b) is a consequence of C5, C1' and C2'.

c) If two points are contained in a common cycle we get from C2' that $P \not\parallel Q$. Now let be $P \not\parallel Q$ and z a cycle containing Q (exists because of a)). C4 guarantees a cycle containing P, Q .

□

Analogously to Moebius- and Laguerre-planes we get the connection to the linear geometry via the *residues*.

Definition 5.3 For a Minkowski-plane $\mathfrak{M} = (\mathcal{P}, \mathcal{Z}; \parallel_+, \parallel_-, \in)$ and $P \in \mathcal{P}$ we define

$$\mathfrak{A}_P := (\mathcal{P} \setminus \overline{P}, \{z \setminus \{\overline{P}\} \mid P \in z \in \mathcal{Z}\} \cup \{E \setminus \overline{P} \mid E \in \mathcal{E} \setminus \{\overline{P}_+, \overline{P}_-\}\}, \in)$$

and call it the **residue at point P**.

An immediate consequence of axioms C1 - C4 and C1', C2' are the following two theorems.

Theorem 5.4 For a Minkowski-plane $\mathfrak{M} = (\mathcal{P}, \mathcal{Z}; \parallel_+, \parallel_-, \in)$ we have:

- a) Any residue is an affine plane.
- b) For any cycle z and any point $P \in \mathcal{P} \setminus z$ the set $z \setminus \overline{P}$ is a hyperbolic curve of \mathfrak{A}_P (see Section 2.1)

Theorem 5.5 Let be $\mathfrak{M} = (\mathcal{P}, \mathcal{Z}; \parallel_+, \parallel_-, \in)$ an incidence structure with two equivalence relations \parallel_+ and \parallel_- on the set \mathcal{P} of points (see above). Then:

\mathfrak{M} is a Minkowski-plane if and only if for any point P the incidence structure (residue)

$$\mathfrak{A}_P := (\mathcal{P} \setminus \overline{P}, \{z \setminus \{\overline{P}\} \mid P \in z \in \mathcal{Z}\} \cup \{E \setminus \overline{P} \mid E \in \mathcal{E} \setminus \{\overline{P}_+, \overline{P}_-\}\}, \in)$$

is an affine plane.

The **minimal model** of a Minkowski-plane can be established over the set $\overline{K} := \{0, 1, \infty\}$ of three elements:

$\mathcal{P} := \overline{K}^2$, $\mathcal{Z} := \{(a_1, b_1), (a_2, b_2), (a_3, b_3) \mid \{a_1, a_2, a_3\} = \{b_1, b_2, b_3\} = \overline{K}\}$,
 $(x_1, y_1) \parallel_+ (x_2, y_2)$ if and only if $x_1 = x_2$ and $(x_1, y_1) \parallel_- (x_2, y_2)$ if and only if $y_1 = y_2$.

Hence: $|\mathcal{P}| = 9$ and $|\mathcal{Z}| = 6$.

For finite Minkowski-planes we get from C1', C2':

Lemma 5.6 Let be $\mathfrak{M} = (\mathcal{P}, \mathcal{Z}; \parallel_+, \parallel_-, \in)$ a finite Minkowski-plane, i.e. $|\mathcal{P}| < \infty$. For any pair of cycles z_1, z_2 and any pair of generators e_1, e_2 we have: $|z_1| = |z_2| = |e_1| = |e_2|$.

This gives rise of

Definition 5.4 For a finite Minkowski-plane \mathfrak{M} and a cycle z of \mathfrak{M} we call the integer $n = |z| - 1$ the **order** of \mathfrak{M} .

Simple combinatorial considerations yield (see [BP'83])

Lemma 5.7 For a finite Minkowski-plane $\mathfrak{M} = (\mathcal{P}, \mathcal{Z}; \parallel_+, \parallel_-, \in)$ the following is true:

- a) Any residue (affine plane) has order n .
- b) $|\mathcal{P}| = (n + 1)^2$, c) $|\mathcal{Z}| = (n + 1)n(n - 1)$.

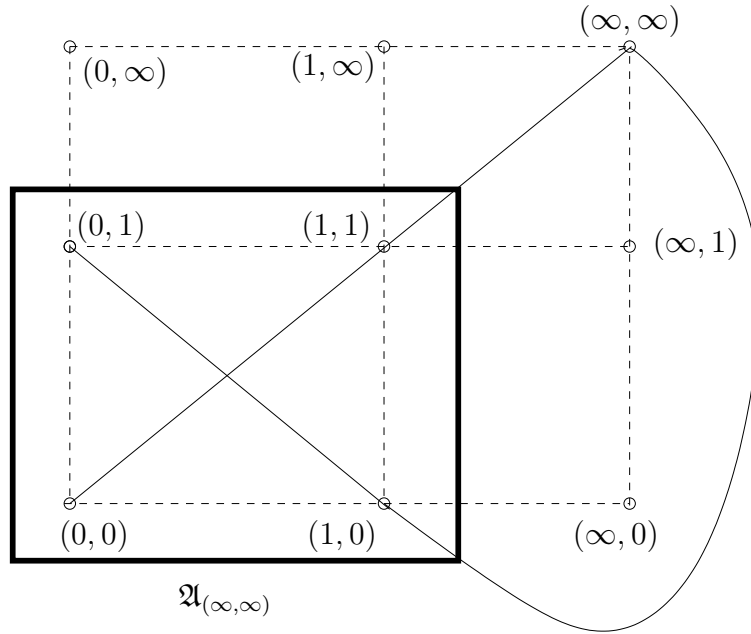

Figure 5.2: Minimalmodel of a Minkowski-plane

5.3 Miquelian Minkowski-planes

5.3.1 The incidence structure $\mathfrak{M}(K)$

We get the most important examples of Minkowski-planes by generalizing the classical real model: Just replace \mathbb{R} by an arbitrary (commutative) field K :

$\mathcal{P} := (K \cup \{\infty\})^2 = K^2 \cup (\{\infty \times K\} \cup \{K \times \{\infty\}) \cup \{(\infty, \infty)\}$, $\infty \notin K$, the set of **points**,

$\mathcal{Z} := \{ \{(x, y) \in K^2 \mid y = ax + b\} \cup \{(\infty, \infty)\} \mid a, b \in K, a \neq 0\}$
 $\cup \{ \{(x, y) \in K^2 \mid y = \frac{a}{x-b} + c, x \neq b\} \cup \{(b, \infty), (\infty, c)\} \mid a, b, c \in K, a \neq 0\}$, the set of **cycles**.

On point set \mathcal{P} we define:

$(x_1, y_1) \parallel_+ (x_2, y_2)$ if and only if $x_1 = x_2$ and $(x_1, y_1) \parallel_- (x_2, y_2)$ if and only if $y_1 = y_2$.

We use the abbreviation $\mathfrak{M}(K) := (\mathcal{P}, \mathcal{Z}; \parallel_+, \parallel_-, \in)$.

In order to prove that $\mathfrak{M}(K)$ is a Minkowski-plane we look for symmetries first. Similar to the real case it is advantageous to describe the set of cycles \mathcal{Z} by the permutation group $PGL(2, K)$ operating on $K \cup \{\infty\}$ (see Section 5.1):

$\mathcal{Z} = \{ \{(x, y) \in \mathcal{P} \mid y = \pi(x)\} \mid \pi \in PGL(2, K)\}$.

5.3.2 Automorphisms of $\mathfrak{M}(K)$. $\mathfrak{M}(K)$ is a Minkowski-plane

Definition 5.5 Any automorphism of the incidence structure $(\mathcal{P}, \mathcal{Z}, \in)$ is called automorphism of $\mathfrak{M}(K)$.

Analogously to the real case we get

Lemma 5.8 The following permutations of point set \mathcal{P} are automorphisms of $\mathfrak{M}(K)$:

- a) $(x, y) \rightarrow (y, x)$,
- b) $(x, y) \rightarrow (\alpha(x), \beta(y))$, with $\alpha, \beta \in PGL(2, K)$,
- c) $(x, y) \rightarrow (\bar{\kappa}(x), \bar{\kappa}(y))$, with $\bar{\kappa}(\infty) = \infty$ and the restriction of $\bar{\kappa}$ onto K is an automorphism of the field $(K, +, \cdot)$.

The proof is a consequence of the fact “ $PGL(2, K)$ is a group” and $\bar{\kappa}\pi\bar{\kappa}^{-1} \in PGL(2, K)$ for any $\bar{\kappa}, \pi \in PGL(2, K)$.

From the 3-transitivity of group $PGL(2, K)$ we get

Lemma 5.9 The automorphism group of $\mathfrak{M}(K)$ operates transitively on

- a) the set of triples of pairwise non parallel points and
 - b) the set of cycles,
- either.

The following list contains some typical automorphisms of structure $\mathfrak{M}(K)$. We define any automorphism by its action on K^2 and extend it using the conventions:

$$k \cdot \infty = \infty, \quad k + \infty = \infty, \quad 1/\infty = 0, \quad 1/0 = \infty.$$

- (1) $(x, y) \rightarrow (x + s, y + t)$, $s, t \in K$,
- (2) $(x, y) \rightarrow (sx, y)$, $s \in K \setminus \{0\}$,
- (3) $(x, y) \rightarrow (x, ty)$, $t \in K \setminus \{0\}$,
- (4) $(x, y) \rightarrow (\frac{1}{x}, y)$, ($CharK \neq 2$: reflection in $\mathfrak{A}_{(1,0)}$ at line $x = -1$,
 $CharK = 2$: translation in $\mathfrak{A}_{(1,0)}$),
- (5) $(x, y) \rightarrow (x, \frac{1}{y})$, (analogously to (4))
- (6) $(x, y) \rightarrow (\frac{1}{x}, \frac{1}{y})$, ($CharK \neq 2$: reflection in $\mathfrak{A}_{(1,1)}$ at point $(-1, -1)$,
 $CharK = 2$: translation in $\mathfrak{A}_{(1,1)}$),
- (7) $(x, y) \rightarrow (y, x)$, ($CharK \neq 2$: reflection in $\mathfrak{A}_{(\infty,\infty)}$ at line $y = x$,
 $CharK = 2$: shear in $\mathfrak{A}_{(\infty,\infty)}$ at line $y = x$).

Analogously to the Laguerre case one proves

Theorem 5.10 a) $\mathfrak{M}(K)$ is a Minkowski-plane.

b) The automorphisms of Lemma 5.8 generate the full group of automorphisms of $\mathfrak{M}(K)$.

5.3.3 Hyperbolic measure for angles in $\mathfrak{M}(K)$

In order to prove the Theorem of MIQUEL for Minkowski-planes in an analog manner as for Moebius- and Laguerre-planes we introduce a suitable measure for angles between lines with equations $y = mx + c$, $m \neq 0$.

Definition 5.6 For two lines $g_1 : y = m_1x + c_1$, $g_2 : y = m_2x + c_2$, $m_1, m_2 \neq 0$ of affine plane $\mathfrak{A}(K)$ the ordered pair $[g_1, g_2]$ is called **angle** and $\angle(g_1, g_2) = m_1/m_2$ the **measure of angle** $[g_1, g_2]$.

Definition 5.7 For any three non parallel points $P_i = (x_i, y_i)$, $i = 1, 2, 3$, i.e. $x_1 \neq x_2 \neq x_3 \neq x_1$, we set $\angle(P_1, P_2, P_3) := m_{21}/m_{23}$ with $m_{ij} := \frac{y_i - y_j}{x_i - x_j}$.

With this definition we prove the **Theorem of inscribed angle for hyperbolas**.

Theorem 5.11 (4 points on a hyperbola) Four pairwise not parallel points $P_i = (x_i, y_i)$, $i = 1, 2, 3, 4$, lie on a hyperbola $y = \frac{a}{x-b} + c$, $a \neq 0$ if and only if $\angle(P_1, P_3, P_2) = \angle(P_1, P_4, P_2)$.

Proof: I) If P_1, P_2, P_3, P_4 are on a hyperbola $y = \frac{a}{x-b} + c$, $a \neq 0$ then (after simple calculation)

$$\angle(P_1, P_3, P_2) = \dots = (x_2 - b)/(x_1 - b) = \angle(P_1, P_4, P_2).$$

II) For four pairwise not parallel points P_1, P_2, P_3 and $P = (x, y)$ we assume

$$\angle(P_1, P_3, P_2) = \angle(P_1, P, P_2), \text{ i.e. } \frac{(y_3 - y_1)(x_3 - x_2)}{(x_3 - x_1)(y_3 - y_2)} = \frac{(y - y_1)(x - x_2)}{(x - x_1)(y - y_2)}$$

which is the “3-point-form” of a hyperbola (axes parallel to coordinate axes) and hence equivalent to an equation $y = \frac{a}{x-b} + c$ for suitable a, b, c . \square

5.3.4 Theorem of MIQUEL in $\mathfrak{M}(K)$

With the aid of Theorem 5.11 we shall proof the Theorem of MIQUEL and a degeneration of it for a Minkowski-plane $\mathfrak{M}(K)$.

Theorem 5.12 (Theorem of MIQUEL) For the Minkowski-plane $\mathfrak{M}(K)$ the following is true:

If for any 8 pairwise not parallel points P_1, \dots, P_8 which can be assigned to the vertices of a cube such that the points in 5 faces correspond to concyclical quadruples than the sixth quadruple of points is concyclical, too.

(For a better overview in figure 5.3 there are circles drawn instead of hyperbolas)

Proof: Because of the transitivity of the automorphism group of $\mathfrak{M}(K)$ we shall confine on the case $P_8 = (\infty, \infty)$. Let be $P_i = (x_i, y_i)$ for $i = 1, \dots, 7$ with pairwise different x_i and y_i . Using the abbreviation $m_{ij} = \frac{y_i - y_j}{x_i - x_j}$ we get from Theorem 5.11 (see Fig. 5.4): $m_{65}/m_{45} = m_{67}/m_{47}$, $m_{45}/m_{25} = m_{43}/m_{23}$ and, because of collinearity (see Fig.5.4), $m_{16} = m_{67}$, $m_{43} = m_{47}$, $m_{12} = m_{23}$.

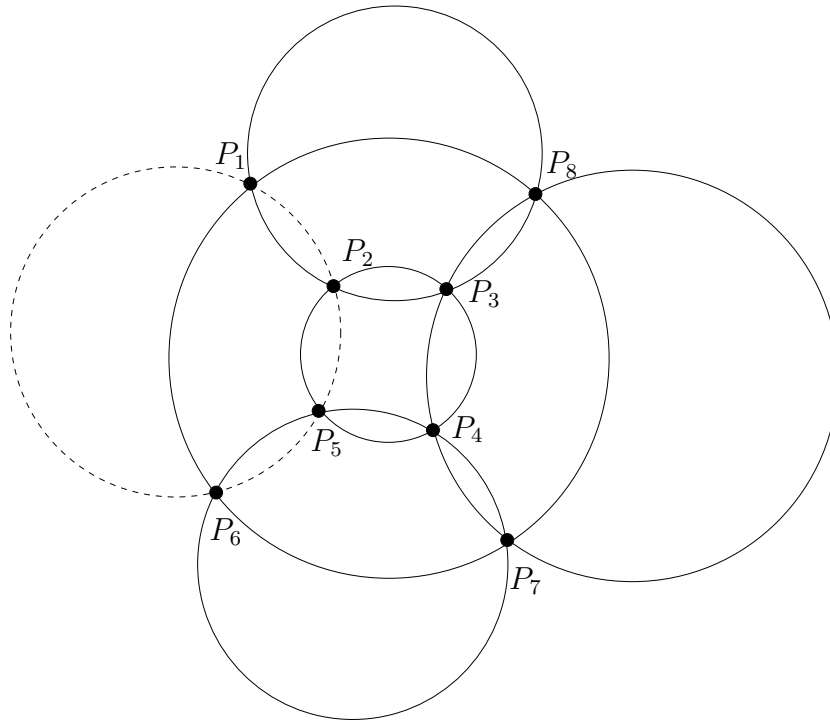

Figure 5.3: Theorem of Miquel for Minkowski-plane $\mathfrak{M}(K)$

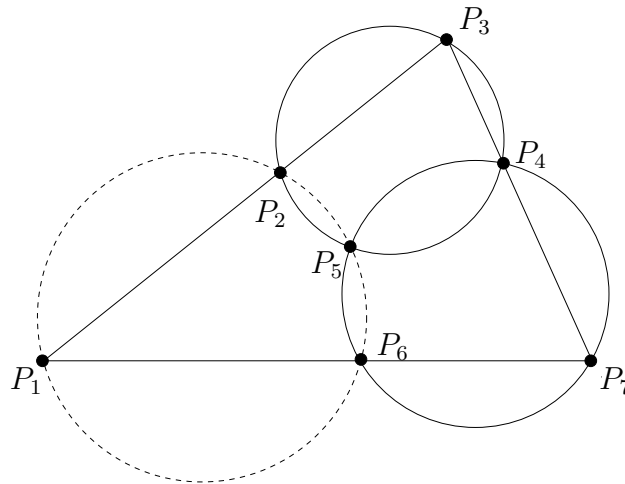

Figure 5.4: Proof of theorem of Miquel for Minkowski-plane $\mathfrak{M}(K)$

Combining these equations leads to:

$$m_{65}/m_{25} = \frac{m_{45}m_{67}}{m_{47}m_{25}} = \frac{m_{25}m_{43}m_{67}}{m_{23}m_{47}m_{25}} = m_{61}/m_{21}.$$

With Theorem 5.11 we conclude: P_1, P_2, P_5, P_6 lie on a common cycle. □

The performance of the proof was literally the same as the proof of the Theorem of MIQUEL for Moebius-planes. The same is true for the following 7-point-degeneration of the Theorem of MIQUEL.

Theorem 5.13 (7 point MIQUEL) *In case of $P_4 = P_5$ Theorem 5.12 is still true.*

The meaning of these Theorems are (see Moebius- and Laguerre-planes):

Result 5.14 (v.d. CHEN [CH'74]) *A Minkowski-plane \mathfrak{M} satisfies the Theorem of MIQUEL if and only if \mathfrak{M} is isomorphic to a Minkowski-plane $\mathfrak{M}(K)$.*

Because of these results we call a Minkowski-plane **miquelian** if it is isomorphic to a Minkowski-plane $\mathfrak{M}(K)$.

Remark 5.2 *a) The minimal model of a Minkowski-plane is miquelian. It is isomorphic to $\mathfrak{M}(K)$ with $K = GF(2)$.*

*b) Even the stronger result is true: Any Minkowski-plane of **even** order is miquelian.*

The following result is a consequence of the Theorem of SEGRE (Theorem 2.27) on ovals in desarguesian planes of odd order.

Result 5.15 (CHEN, KAERLEIN [CH,KA'73]) *A finite Minkowski-plane of **odd** order is miquelian if and only if there exists a desarguesian residue.*

5.3.5 Cycle reflections and the Theorem of Miquel

For any (miquelian) Minkowski-plane $\mathfrak{M}(K)$ the mapping $\bar{\sigma} : (x, y) \rightarrow (y, x)$ is an involutorial automorphism which fixes cycle $y = x$ pointwise and any cycle $y = -x + c$ and $y = \frac{a}{x-b} + b$, respectively, as a whole. For cycle $y = x$ there is exactly one reflection. From the transitivity of the automorphism group of $\mathfrak{M}(K)$ (see Lemma 5.9) we get:

Theorem 5.16 *Let be $\mathfrak{M} = (\mathcal{P}, \mathcal{Z}; \parallel_+, \parallel_-, \in)$ a miquelian Minkowski-plane. Then*

a) For any cycle z there is a reflection at z :

$$\bar{\sigma}_z : P \rightarrow \overline{(\bar{P}_+ \cap z)}_- \cap \overline{(\bar{P}_- \cap z)}_+$$

b) For any cycle z , any point $P \in \mathcal{P} \setminus z$ and cycle z' containing P and $\bar{\sigma}_z(P)$ we have:

$$\bar{\sigma}_z(z') = z'.$$

One easily recognizes: The reflection at cycle $y = ax$ (of Minkowski-plane $\mathfrak{M}(K)$) acts on K^2 as: $(x, y) \rightarrow (a^{-1}y, ax)$. Let be $\bar{\sigma}_a, \bar{\sigma}_b, \bar{\sigma}_c$ the reflection at the cycles $y = ax, y = bx$ and $y = cx$, respectively. On K^2 $\bar{\sigma}_a \bar{\sigma}_b \bar{\sigma}_c$ has the representation $(x, y) \rightarrow (a^{-1}bc^{-1}y, ab^{-1}cx)$, i.e. $\bar{\sigma}_a \bar{\sigma}_b \bar{\sigma}_c$ is the reflection at cycle $y = ab^{-1}cx$. This proves the following theorem (use Lemma 5.9).

Theorem 5.17 (Theorem on 3 reflections) *Let \mathfrak{M} be a miquelian Minkowski-plane, P, Q a pair of non parallel points and $\bar{\sigma}_1, \bar{\sigma}_2, \bar{\sigma}_3$ the reflections at three cycles z_1, z_2, z_3 containing P, Q . Then $\bar{\sigma}_1\bar{\sigma}_2\bar{\sigma}_3$ is the reflection at a cycle z_4 containing P, Q .*

For Minkowski-planes $\mathfrak{M}(K)$ the reflections at cycles passing (∞, ∞) induce reflections at lines (involutorial collineations) at lines $y = ax + b, a \neq 0$ of affine plane $\mathfrak{A}(K)_{(\infty, \infty)}$. Let be Σ_∞ the set of such line reflections. For any two non parallel points $P, Q \in K^2$ there is exactly one $\sigma \in \Sigma_\infty$ with $\sigma(P) = Q$. The corresponding line is called **bisector of P, Q** . In case of $\text{Char}K \neq 2$ the bisector of P, Q intersects the line through P, Q . In case of $\text{Char}K = 2$ the bisector is parallel to the line through P, Q . For two reflections $\sigma_1, \sigma_2 \in \Sigma_\infty$ corresponding to two *parallel* lines $\sigma_1\sigma_2$ is a translation. If σ_1, σ_2 are reflections of non parallel lines containing point $A = (x_0, y_0)$, then $\sigma_1\sigma_2$ is a **Minkowski rotation** at point A , i.e. $\sigma_1\sigma_2$ fixes the hyperbola $y = \frac{a}{x-x_0} + y_0$ (because of Theorem 5.16 b)) and A is the unique fixpoint in case of $\sigma_1 \neq \sigma_2$. Especially we get

Lemma 5.18 *Let be P_1, P_2, P_3, P_4 four non parallel points of residue $\mathfrak{A}_{(\infty, \infty)}$ of Minkowski-plane $\mathfrak{M}(K)$, which are not collinear, and $\sigma_{ik} \in \Sigma_\infty$ the reflection which exchanges P_i and P_k . Then: P_1, P_2, P_3, P_4 lie on a hyperbola $y = \frac{a}{x-b} + c$ if and only if $\sigma_{12}\sigma_{23}\sigma_{34} = \sigma_{14}$.*

Proof: I) If P_1, P_2, P_3, P_4 are on a hyperbola $y = \frac{a}{x-x_0} + y_0$ one proves by an easy calculation, that all bisector lines (of the points) contain point $P = (x_0, y_0)$. With Theorem 5.17 we get the statement.

II) In case of $\sigma_{12}\sigma_{23}\sigma_{34} = \sigma_{14}$ the Minkowski-rotation $\psi : \sigma_{12}\sigma_{23} = \sigma_{14}\sigma_{43}$ leaves the hyperbola h determined by P_1, P_2, P_3 and h' determined by P_1, P_3, P_4 , respectively, invariant. Because for any Minkowski-rotation and any point P , different from the center of rotation, there is exactly one fix-hyperbola containing P . Hence we have $h = h'$ and the existence of a common hyperbola. \square

Remark 5.3 *With help Lemma of 5.18 one gets a further proof of the Theorem of Miquel:*

P_1, \dots, P_8 are chosen as described for the proof of Theorem 5.12: $P_8 = (\infty, \infty)$ and $P_i \in K^2$ for $i = 1, \dots, 7$. Let be $\sigma_{ik} \in \Sigma_\infty$ the reflection which exchanges P_i and P_k .

Because of Lemma 5.18 we have:

$\sigma_{56} = \sigma_{54}\sigma_{47}\sigma_{76}$, $\sigma_{54} = \sigma_{52}\sigma_{23}\sigma_{34}$, and $\sigma_{16}\sigma_{67}$, $\sigma_{34}\sigma_{47}$, $\sigma_{12}\sigma_{23}$, are translations with $(\sigma_{12}\sigma_{23})(\sigma_{34}\sigma_{47}) = \sigma_{16}\sigma_{67}$. Hence

$$\sigma_{56} = \sigma_{54}\sigma_{47}\sigma_{76} = \sigma_{52}\sigma_{23}\sigma_{34}\sigma_{47}\sigma_{76} = \sigma_{52}\sigma_{12}(\sigma_{12}\sigma_{23})(\sigma_{34}\sigma_{47})\sigma_{76} = \sigma_{52}\sigma_{12}\sigma_{16}\sigma_{67}\sigma_{76} = \sigma_{52}\sigma_{21}\sigma_{16}$$

and Lemma 5.18 proves: P_1, P_2, P_5, P_6 lie on a cycle. \square

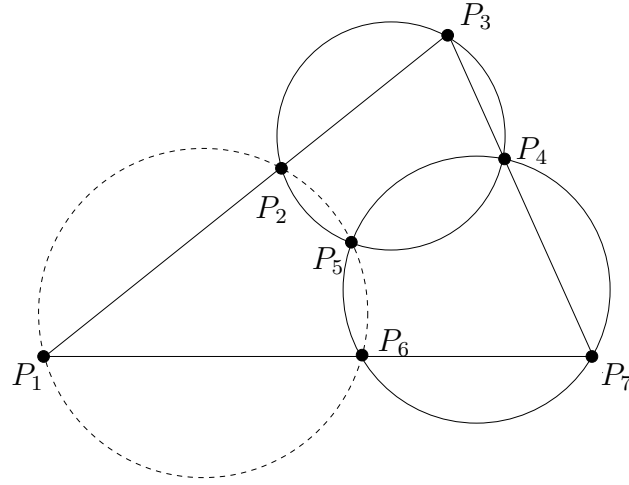

Figure 5.5: Proof of theorem of Miquel for Minkowski-plane $\mathfrak{M}(K)$

5.3.6 The hyperboloid model of a miquelian Minkowski-plane

Remark 5.4 For Moebius- and Laguerre-planes there are the wide classes of ovoidal models. Ovoidal Minkowski-planes coincide with the class of miquelian Minkowski-planes, because a “non degenerated quadratic set of index 2” (i.e. the formal generalization of a hyperboloid of one sheet) in a projective space is already a quadric hence a hyperboloid of one sheet (see Chapter 6.3).

Let be K a field and $\mathfrak{P}(K)$ the projective 3-space over K . There exists exactly one non degenerated quadric \mathcal{H} of index 2 in $\mathfrak{P}(K)$. We call it just *hyperboloid* (see 6). We assume the coordinates are chosen such that

$$\mathcal{H} = \{ \langle (X_1, X_2, X_3, X_4) \rangle \mid (X_1, X_2, X_3, X_4) \neq (0, 0, 0, 0) \text{ with } x_1x_2 + x_3x_4 = 0 \}.$$

The tangentplanes can be described using the bilinear form f of the corresponding quadratic form $\rho(\mathbf{x}) = x_1x_2 + x_3x_4$, $\mathbf{x} = (x_1, x_2, x_3, x_4)$:

$$f(\mathbf{x}, \mathbf{y}) = \rho(\mathbf{x} + \mathbf{y}) - \rho(\mathbf{x}) - \rho(\mathbf{y}) = x_1y_2 + x_2y_1 + x_3y_4 + x_4y_3.$$

(See Chapter 6.3.) Hence a plane $ax_1 + bx_2 + cx_3 + dx_4 = 0$ is a tangentplane of \mathcal{H} if and only if $\langle (x_1, x_2, x_3, x_4) \rangle \in \mathcal{H}$, i.e. $(a, b, c, d) \neq (0, 0, 0, 0)$ and $ab + cd = 0$.

Now, we show that the geometry $(\mathcal{P}, \mathcal{Z}, \in)$ of plane sections of \mathcal{H} with

$$\mathcal{P} = \mathcal{H},$$

$$\mathcal{Z} = \{ \varepsilon \cap \mathcal{H} \mid \varepsilon \text{ is plane, that is no tangent plane} \}$$

$$= \{ \{ \langle (x_1, x_2, x_3, x_4) \rangle \in \mathcal{H} \mid ax_1 + bx_2 + cx_3 + dx_4 = 0 \} \mid a, b, c, d \in K \text{ with } ab + cd = 0 \}$$

is isomorphic to Minkowski-plane $\mathfrak{M}(K)$:

The *stereographic projection*

$$\psi : \begin{cases} \mathcal{P} & \rightarrow (K \cup \{\infty\})^2 \\ \langle (0, 0, 1, 0) \rangle & \rightarrow (\infty, \infty) \\ \langle (1, 0, u, 0) \rangle & \rightarrow (\infty, -u) \\ \langle (0, 1, v, 0) \rangle & \rightarrow (-v, \infty) \\ \langle (x, y, -xy, 1) \rangle & \rightarrow (x, y) \end{cases}$$

maps the cycle with equation $ax_1 + bx_2 + dx_4 = 0$ (i.e. $c = 0!$) onto

$$\{(x, y) \in K^2 \mid y = -\frac{ax+d}{b}\} \cup \{(\infty, \infty)\}$$

and the cycle with equation $ax_1 + bx_2 + cx_3 + dx_4 = 0$, $c \neq 0$ onto

$$\{(x, y) \in K^2 \mid y = -\frac{ax+d}{cx-b}, x \neq \frac{b}{c}\} \cup \{(\infty, \frac{a}{c}), (\frac{b}{c}, \infty)\}.$$

(In any case the constraint $ab + cd \neq 0$ is valid.)

Obviously ψ is an isomorphism from $(\mathcal{P}, \mathcal{Z}, \in)$ onto $\mathfrak{M}(K)$.

5.3.7 The bundle theorem for Minkowski-planes

Similar to Moebius- and Laguerre-planes we have a *Bundle Theorem*. But for Minkowski-planes there are no non miquelian ovoidal Minkowski-planes.

Theorem 5.19 (Bundle Theorem) *For a miquelian Minkowski-plane \mathfrak{M} the following statement holds:*

Let be $A_1, A_2, A_3, A_4, B_1, B_2, B_3, B_4$ eight pairwise non parallel points. If 5 of the six quadruples $Q_{ij} := \{A_i, B_i, A_j, B_j\}$, $i < j$, are concyclical on at least 4 cycles k_{ij} then this is true for the last quadruple, too (see Theorem 3.25).

Proof: Analogously to the Bundle Theorem for ovoidal Moebius-planes (Theorem 3.25).

Unlike the Moebius and the Laguerre case the Bundle Theorem for Minkowski-planes is equivalent to the Theorem of Miquel.

Result 5.20 (KAHN, [KH'80]) *A Minkowski-plane is miquelian if and only if the Bundle Theorem (Theorem 5.19) holds.*

5.4 Minkowski-planes over TITS-nearfields

5.4.1 The incidence structure $\mathfrak{M}(K, f)$

Looking for further examples of Minkowski-planes we shall consider the close connection between a miquelian Minkowski-plane $\mathfrak{M}(K)$ and the group $PGL(2, K)$. There are a lot of sharply 3-transitive operating permutation groups which are no $PGLs$. They are all defined via *TITS-nearfields* (see Chapter 7). One may consider such a group as a generalization of the group of fractional linear mappings.

Let be $(K, +, \cdot, f)$ a **planar TITS-nearfield** (see 7) and $\infty \notin K$. We define:

$a \cdot \infty = \infty, b + \infty = \infty$ for $a, b \in K, a \neq 0$, and

$\bar{f}: K \cup \{\infty\} \rightarrow K \cup \{\infty\}$ with $\bar{f}(x) = f(x)$ for $x \in K \setminus \{0\}$, $\bar{f}(\infty) = 0, \bar{f}(0) = \infty$.

Hence the set of permutations

$\Pi(K, f) := \{x \rightarrow ax + b \mid a, b \in K, a \neq 0\} \cup \{x \rightarrow af(x - b) + c \mid a, b, c \in K, a \neq 0\}$
is a group which operates sharply 3-transitive on $K \cup \{\infty\}$ (see 7).

Herewith we define

$\mathcal{P} := (K \cup \{\infty\})^2$, the set of **points**

$\mathcal{Z} := \{\{(x, y) \in \mathcal{P} \mid y = \pi(x)\} \mid \pi \in \Pi(K, f)\}$ the set of **cycles**,

$(x_1, y_1) \parallel_+ (x_2, y_2)$ iff $x_1 = x_2$, $(x_1, y_1) \parallel_- (x_2, y_2)$ iff $y_1 = y_2$, and

$\mathfrak{M}(K, f) := (\mathcal{P}, \mathcal{Z}; \parallel_+, \parallel_-, \in)$.

The proof that $\mathfrak{M}(K, f)$ is a Minkowski-plane will be performed in the same way as for the miquelian examples.

5.4.2 Automorphisms of $\mathfrak{M}(K, f)$. $\mathfrak{M}(K, f)$ is a Minkowski-plane

Alike the miquelian case it is easy to find automorphisms of the incidence structure $(\mathcal{P}, \mathcal{Z}, \in)$ of $\mathfrak{M}(K, f)$, which we call **automorphisms** of $\mathfrak{M}(K, f)$.

Lemma 5.21 *Any of the following permutations of \mathcal{P} is an automorphism of $\mathfrak{M}(K, f)$.*

a) $(x, y) \rightarrow (y, x)$

b) $(x, y) \rightarrow (\alpha(x), \beta(y))$, with $\alpha, \beta \in \Pi(K, f)$

c) $(x, y) \rightarrow (\bar{\kappa}(x), \bar{\kappa}(y))$, where $\bar{\kappa}(\infty) = \infty$ and the restriction of $\bar{\kappa}$ onto K is an automorphism of the TITS-nearfield $(K, +, \cdot, f)$ (see 7).

The proof results from the fact that $\Pi(K, f)$ is a group and the permutability of an automorphism of TITS-nearfield $(K, +, \cdot, f)$ with function f .

From the 3-transitivity of $\Pi(K, f)$ we get

Lemma 5.22 *The automorphism group of $\mathfrak{M}(K, f)$ operates transitively*

a) *on the triples of points which are pairwise not parallel and*

b) *on the set of cycles.*

Herewith we proof the following theorem.

Theorem 5.23 *$\mathfrak{M}(K, f)$ is a Minkowski-plane.*

Proof: Obviously the relations \parallel_+ and \parallel_- are equivalence relations on \mathcal{P} . Because of the planarity of the nearfield K the residue $\mathfrak{A}_{(\infty, \infty)}$ (see Theorem 5.4) is an affine plane. And from Lemma 5.22 we get: *Any residue is an affine plane.* Theorem 5.4 completes the proof. \square

Remark 5.5 *One easily checks that the list of automorphisms given in Section 5.3.2 is valid for $\mathfrak{M}(K, f)$ if one replaces $\frac{1}{x}$ and $\frac{1}{y}$ by $\bar{f}(x)$ and $\bar{f}(y)$, respectively. Even their geometrical meaning can be adopted literally. The essential difference between a miquelian Minkowski-plane and one over a TITS-nearfield is the following one: Because of automorphisms (2) and (3) (of the list mentioned above) and the commutativity in the miquelian case any mapping $(x, y) \rightarrow (xs, ys), s \in K \setminus \{0\}$ is an automorphism, too. This not true for a Minkowski-plane over a proper TITS-nearfield.*

Alike the miquelian case (see Theorem 5.10) we get

Result 5.24 (Wefelscheid, [WE'77]) *The automorphisms of Lemma 5.21 generate the full group of automorphisms of Minkowski-plane $\mathfrak{M}(K, f)$.*

5.5 Minkowski-planes and sets of permutations

Another idea to find further examples of Minkowski-planes exploits the connection of an arbitrary Minkowski-plane and sharply 3-transitive operating sets of permutations.

5.5.1 Description of a Minkowski-plane by permutation sets

Let be $\mathfrak{M} = (\mathcal{P}, \mathcal{Z}; \|_+, \|_-, \in)$ a Minkowski-plane, z_0 a cycle, E_0^- a generator ($\in \mathcal{E}^-$) and $K \cup \{\infty\}, \infty \notin K$, the set of points of E_0^- such that $\infty \notin E_0^- \cap z_0$. With help of E_0^- and z_0 we define a bijection ψ from \mathcal{P} onto $(K \cup \{\infty\})^2$:

$$\psi : \begin{cases} \mathcal{P} & \rightarrow & (K \cup \{\infty\})^2 \\ P & \rightarrow & \overline{(\bar{P}_+ \cap E_0^-, (\bar{P}_- \cap z_0)_+ \cap E_0^-)} \end{cases}$$

Identifying \mathcal{P} and $\psi(\mathcal{P})$ we get

$$\mathcal{P} = (K \cup \{\infty\})^2 \quad \text{and}$$

$$(x_1, y_1) \|_+ (x_2, y_2) \text{ iff } x_1 = x_2, \quad (x_1, y_1) \|_- (x_2, y_2) \text{ iff } y_1 = y_2.$$

To any cycle z we assign a permutation π_z of $K \cup \{\infty\}$:

$$\pi_z : \begin{cases} K \cup \{\infty\} & \rightarrow & K \cup \{\infty\} \\ x & \rightarrow & \overline{((\bar{x}_+ \cap z)_- \cap z_0)_+ \cap E_0^-} \end{cases} .$$

Because of axiom (C3) the permutation set $\Pi(z_0, E_0^-) := \{\pi_z \mid z \in \mathcal{Z}\}$ operates sharply 3-transitive on $K \cup \{\infty\}$.

Remark 5.6 *If \mathfrak{M} is a Minkowski-plane $\mathfrak{M}(K, f)$ over a TITS-nearfield, z_0 the cycle $y = x$ and E_0^- the generator $y = 0$ we get $\Pi(z_0, E_0^-) = \Pi(K, f)$. Especiallay $\Pi(z_0, E_0^-)$ is a group. In Section 5.5.2 we shall recognize that this property is typical for Minkowski-planes over TITS-nearfields. (Notice: Till now (1985) it is unknown if any sharply 3-transitive permutation group can be described over a TITS-nearfield. For permutationgroups coming with Minkowski-planes this is always true, see Section 5.5.2.) Hence*

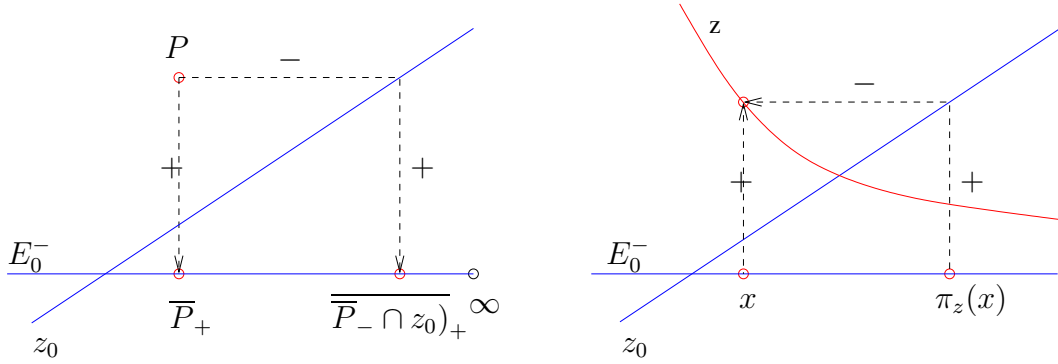

Figure 5.6: Minkowski-plane and permutation sets

essentially new examples of Minkowski-planes must have the property $\Pi(z_0, E_0^-)$ is **not** a group (see Section 5.6.2).

5.5.2 Minkowski-planes over permutation groups

In this section $\mathfrak{M} = (\mathcal{P}, \mathcal{Z}; \|_+, \|_-, \in)$ is a minkowski-plane with the following property

(G) There is a cycle z_0 and a generator $E_0^- \in \mathcal{E}^-$ such that $\Pi(z_0, E_0^-)$ is a group.

We describe \mathfrak{M} as introduced in the previous section:

$$\mathcal{P} = (K \cup \{\infty\})^2 \quad \text{and}$$

$$\mathcal{Z} := \{ \{(x, y) \in \mathcal{P} \mid y = \pi(x)\} \mid \pi \in \Pi(z_0, E_0^-) \}$$

Obviously we get from property (G)

Lemma 5.25 *The mappings $(x, y) \rightarrow (y, x)$ and $(x, y) \rightarrow (\alpha(x), \beta(y))$, $\alpha, \beta \in \Pi(z_0, E_0^-)$, are automorphisms of \mathfrak{M} (i.e. $(\mathcal{P}, \mathcal{Z}, \in)$).*

Lemma 5.26 *The automorphism group of \mathfrak{M} operates transitively*
 a) *on the triples of pairwise non parallel points and*
 b) *on the set of cycles.*

Now we define operations $+$ and \cdot on K such that $(K, +, \cdot)$ will be a nearfield:

Let be $0 \in K$ the common point of z_0 and E_0^- , $1 \in K \setminus \{0\}$ and Π_∞ and $\Pi_{0\infty}$ the subgroups of $\Pi(z_0, E_0^-)$, whose elements fix point ∞ and points $0, \infty$, respectively. More over let be $\tilde{\Pi}_\infty := \{ \pi \in \Pi_\infty \mid \pi(x) \neq x \text{ for all } x \in K \} \cup \{id\}$. The elements of $\tilde{\Pi}_\infty$ are represented by the lines $\mathfrak{A}_{(\infty, \infty)}$ parallel to line $y = x$. The following properties hold:

- (i) $\tilde{\Pi}_\infty$ contains the identity.
- (ii) For $\tau \in \tilde{\Pi}_\infty$ we get $\tau^{-1} \in \tilde{\Pi}_\infty$.

(iii) For $\tau_1, \tau_2 \in \tilde{\Pi}_\infty$ we get $\tau_1\tau_2 \in \tilde{\Pi}_\infty$.

(iv) For $\tau_1, \tau_2 \in \tilde{\Pi}_\infty$ and $x_0 \in K$ we get from $\tau_1(x_0) = \tau_2(x_0)$ the equation $\tau_1 = \tau_2$.

(For the proof of these statements prove (iv) before (iii).)

Hence $\tilde{\Pi}_\infty$ is a permutation group of K which operates sharply transitive (regular).

Below let be $\tau_a \in (\pi_b, b \in K \setminus \{0\})$ the unique mapping out of $\tilde{\Pi}_\infty$ (of $\Pi_{0\infty}$) with $\tau(0) = a$ ($\pi_b(1) = b$). On the set K we define the operations $+$ and \cdot , respectively, by

$$+ : \begin{cases} K^2 & \rightarrow K \\ (a, b) & \rightarrow \tau_a(b) \end{cases} \quad \cdot : \begin{cases} K^2 & \rightarrow K \\ (a, b) & \rightarrow 0, \text{ if } a = 0 \text{ or } b = 0 \\ (a, b) & \rightarrow \pi_a(b) \text{ if } a \neq 0 \text{ and } b \neq 0. \end{cases}$$

$(K, +, \cdot)$ has the following properties:

(F1): $(K, +)$ is a group (0 is the neutral element).

(F2): $(K \setminus \{0\}, \cdot)$ is a group (1 is the neutral element).

Because of $a(b+c) = \pi_a\tau_b(c) = \pi_a\tau_b\pi_a^{-1}\pi_a(c) = \tau_{\pi_a(b)}\pi_a(c) = \tau_{ab}\pi_a(c) = ab+ac$ for any $a, b, c \in K$ we get

(F3): $a(b+c) = ab+ac$ for any $a, b, c \in K$.

(F4): $0a = 0$ for any $a \in K$.

An algebraic structure $(K, +, \cdot)$ with properties (F1) – (F4) is called *nearfield* (s. Chapter 7). For a nearfield $(K, +, \cdot)$ group $(K, +)$ is commutative, -1 is an element of the center and equation $x^2 = 1$ has only the solutions 1 and -1 (s. Section 7.1).

Because $\{x \rightarrow ax+b \mid a, b \in K, a \neq 0\}$ operates sharply 2-transitive on K , like Π_∞ does, and is a subgroup of the restriction of Π_∞ on K we get

$$\Pi_\infty = \left\{ \begin{array}{l} \infty \rightarrow \infty \\ x \rightarrow ax+b \end{array} \mid a, b \in K, a \neq 0 \right\}, \quad \tilde{\Pi}_\infty = \left\{ \begin{array}{l} \infty \rightarrow \infty \\ x \rightarrow x+b \end{array} \mid b \in K \right\} \text{ and}$$

$$\Pi_{0\infty} = \left\{ \begin{array}{l} \infty \rightarrow \infty \\ x \rightarrow ax \end{array} \mid a \in K, a \neq 0 \right\}.$$

Obviously the lines of residue $\mathfrak{A}_{(\infty, \infty)}$ are represented by equations $y = ax+b$ and $x = c$. From the parallel axiom of an affine plane we find that any line $y = ax+b$ with $a \neq 1$ intersects line $y = x$ and nearfield $(K, +, \cdot)$ has the following property:

(p) For any $a, b \in K$ with $a \neq 1$ equation $ax - x = b$ has a solution in K .

Hence $(K, +, \cdot)$ is a **planar** nearfield (s. Section 7.3. In order to verify property (t) below, we consider:

If $\bar{f} \in \Pi(z_0, E_0^-)$ and $\bar{f}(1) = 1, \bar{f}(0) = \infty, \bar{f}(\infty) = 0$ then

$$\bar{f}(ab) = \bar{f}(\pi_a(b)) = \bar{f}\pi_a\bar{f}^{-1}\bar{f}(b) = \pi_{\bar{f}(a)}\bar{f}(b) = \bar{f}(a)\bar{f}(b) \text{ for any } a, b \in K \setminus \{0\}.$$

For a nearfield equation $x^2 = 1$ has only the two solutions 1 and -1 . From $\bar{f}(ab) =$

$\bar{f}(a)\bar{f}(b)$ we get $\bar{f}(-1) = -1$. Hence both the mappings $\bar{f}\tau_1\bar{f}$ and $\tau_1\pi_{-1}\bar{f}\tau_1$ fix 0, map ∞ onto 1 and -1 onto ∞ with consequence: $\bar{f}\tau_1\bar{f} = \tau_1\pi_{-1}\bar{f}\tau_1$. For $x \in K \setminus \{0, -1\}$ we get the equation

$$\bar{f}(1 + \bar{f}(x)) = 1 + (-1)\bar{f}(1 + x).$$

From $\bar{f}^2(1) = 1, \bar{f}^2(0) = 0, \bar{f}^2(\infty) = \infty$ and the property “ $\Pi(z_0, E_0^-)$ operates sharply 3-transitive” we get: $\bar{f}^2 = id$.

We assign the restriction of \bar{f} on $K \setminus \{0\}$ by f and get from the commutativity of $(K, +)$:

- (t) *There exists an involutory automorphism f of $(K \setminus \{0\}, \cdot)$ with*
 $f(f(x) + 1) = 1 - f(x + 1)$ for any $x \in K \setminus \{0, -1\}$.

A nearfield with property (t) is called **TITS-nearfield** (s. Section 7.5).

We conclude:

Theorem 5.27 *A Minkowski plane $\mathfrak{M} = (\mathcal{P}, \mathcal{Z}; \parallel_+, \parallel_-, \in)$ is isomorphic to a Minkowski-plane $\mathfrak{M}(K, f)$ over a TITS-nearfield if and only if*

- (G) *There is a cycle z_0 and a generator $E_0^- \in \mathcal{E}^-$ such that $\Pi(z_0, E_0^-)$ is a group.*

Remark 5.7 *From the abundance of the automorphism group of a Minkowski-plane we find:*

Property (G) for a pair z_0, E_0^- implies the validity of (G) for any pair z, E .

5.5.3 Symmetry at a cycle. The rectangle axiom

Definition 5.8 *Let be $\mathfrak{M} = (\mathcal{P}, \mathcal{Z}; \parallel_+, \parallel_-, \in)$ a Minkowski-plane and z a cycle.*

- a) *The involution $\sigma_z : \begin{cases} \mathcal{P} & \rightarrow \mathcal{P} \\ P & \rightarrow \overline{(\overline{P_+ \cap z})_- \cap (\overline{P_- \cap z})_+} \end{cases}$ is called **symmetry at z** .*
- b) *The symmetry at z is called **reflection at z** if σ_z is an automorphism of \mathfrak{M} (s. Section 5.7).*
- c) *Two points **P, Q** are called **symmetric to z** if $\sigma_z(P) = Q$ (hence $\sigma_z(Q) = P$).*
- d) *A cycle **z'** is called **symmetric to z** if $\sigma_z(z') = z'$.*
- e) *The Minkowski-plane \mathfrak{M} is called **symmetric to z** if σ_z is an reflection (automorphism).*

A Minkowski-plane over a TITS-nearfield is symmetric to any cycle. But there are Minkowski-planes with symmetries which are no reflections (s. Section 5.6.2).

In any case the following is true.

Lemma 5.28 *For any Minkowski-plane \mathfrak{M} described by sets of permutations (s. Section 5.5.1) the mapping $(x, y) \rightarrow (y, x)$ is the symmetry at cycle z_0 .*

With Lemma 5.28 we prove

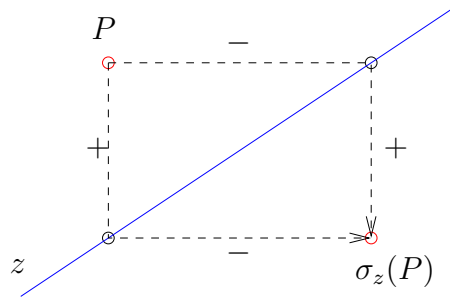

Figure 5.7: Definition of a symmetry at a cycle

Lemma 5.29 For any Minkowski-plane \mathfrak{M} described by sets of permutations (s. Section 5.5.1) the following statements are equivalent.

- a) For any $\pi \in \Pi(z_0, E_0^-)$ we have $\pi^{-1} \in \Pi(z_0, E_0^-)$.
- b) \mathfrak{M} is symmetric to cycle z_0 .

Proof: By the symmetry $\sigma_{z_0} : (x, y) \rightarrow (y, x)$ cycle $y = \pi(x)$ is sent to curve $y = \pi^{-1}(x)$ which is a cycle if and only if $\pi^{-1} \in \Pi(z_0, E_0^-)$. Hence σ_{z_0} is an automorphism if and only if $\pi^{-1} \in \Pi(z_0, E_0^-)$. \square

The rectangle axiom (s. Theorem 5.30) is a tool to decide whether $\Pi(z_0, E_0^-)$ is a group.

Definition 5.9 Any 4 points P, Q, R, S define a **rectangle**, denoted by $[P, Q; R, S]$ if $P \parallel R$ and $\{Q\} = \overline{P}_- \cap \overline{R}_+$, $\{S\} = \overline{P}_+ \cap \overline{R}_-$.

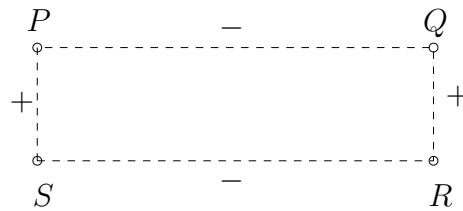

Figure 5.8: Definition of a rectangle

Theorem 5.30 For any Minkowski-plane \mathfrak{M} described by sets of permutations (s. Section 5.5.1) the following statements a), b) are equivalent.

- a) The set of permutations $\Pi(z_0, E_0^-)$ is a group.
- b) The **rectangle axiom** is valid:
 Let be $[A_1, A_2; A_3, A_4]$, $[B_1, B_2; B_3, B_4]$, $[C_1, C_2; C_3, C_4]$, $[D_1, D_2; D_3, D_4]$ rectangles such that A_i, B_i, C_i, D_i are four points on a cycle z_i for $i = 1, 2, 3$. Then A_4, B_4, C_4, D_4 are four (different) points on a cycle z_4 , too.

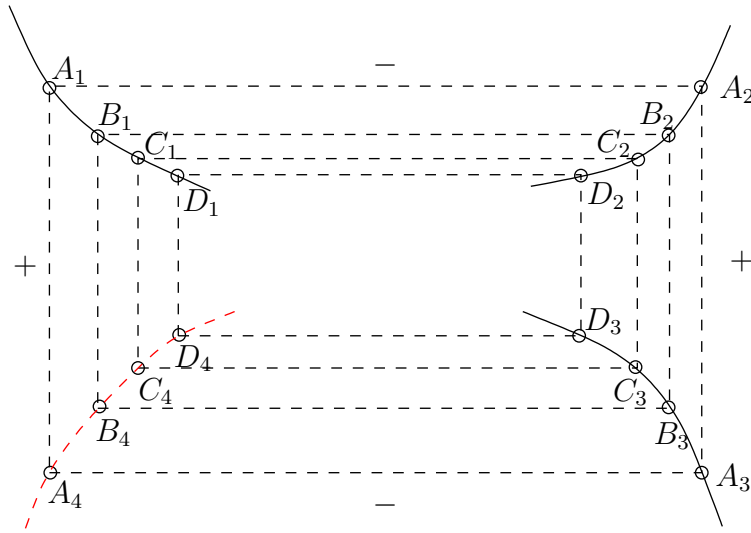

Figure 5.9: The rectangle axiom

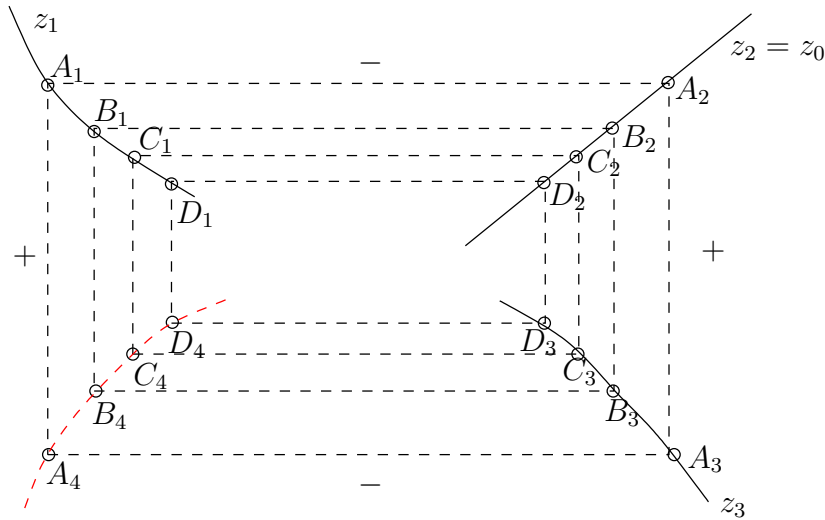

Figure 5.10: To proof of rectangle axiom: a) \rightarrow b)

Proof: a) \rightarrow b): let be $\Pi(z_0, E_0^-)$ a *group*. In this case the automorphism group of \mathfrak{M} operates transitively on the set \mathcal{Z} of cycles (s. Lemma 5.26) and we assume $z_2 = z_0$ (s. Fig. 5.10).

Let be $\pi_i, i = 1, 2, 3$ the permutation of $\Pi(z_0, E_0^-)$ belonging to z_i . We choose $a, b, c, d \in K \cup \{\infty\}$ such that

$$A_1 = (a, \pi_1(a)), B_1 = (b, \pi_1(b)), C_1 = (c, \pi_1(c)), D_1 = (d, \pi_1(d)).$$

From the preconditions for A_i, B_i, C_i, D_i and from $z_2 = z_0$ we get:

$$A_2 = (\pi_1(a), \pi_1(a)), \dots, A_3 = (\pi_1(a), \pi_3\pi_1(a)), \dots, \text{ and at least}$$

$$A_4 = (a, \pi_3\pi_1(a)), B_4 = (b, \pi_3\pi_1(b)), C_4 = (c, \pi_3\pi_1(c)), D_4 = (d, \pi_3\pi_1(d)).$$

Because $\Pi(z_0, E_0^-)$ is a group there exists a $\pi_4 \in \Pi(z_0, E_0^-)$ with $\pi_4 = \pi_3\pi_1$. Hence A_4, B_4, C_4, D_4 are on the cycle $y = \pi_4(x)$.

b) \rightarrow a): I) Let be $\pi_1, \pi_3 \in \Pi(z_0, E_0^-)$ and $a, b, c, d \in K \cup \{\infty\}$ pairwise distinct. We define (see above) $A_1 = (a, \pi_1(a)), \dots, A_2 = (\pi_1(a), \pi_1(a)), \dots, A_3 = (\pi_1(a), \pi_3\pi_1(a)), \dots, A_4 = (a, \pi_3\pi_1(a)), \dots$. The points A_1, \dots, D_4 fulfill the preconditions of the rectangle axiom with the cycles $y = \pi_1(x), y = x, y = \pi_3(x)$. Hence the points $A_4 = (a, \pi_3\pi_1(a)), B_4 = (b, \pi_3\pi_1(b)), C_4 = (c, \pi_3\pi_1(c)), D_4 = (d, \pi_3\pi_1(d))$ are points of a cycle z_4 with equation $y = \pi_4(x)$. Fixing a, b, c we get $\pi_4(d) = \pi_3\pi_1(d)$ for any $d \in K \cup \{\infty\}$ and $\pi_3\pi_1 \in \Pi(z_0, E_0^-)$.

II) Let be $\pi \in \Pi(z_0, E_0^-)$ and z the cycle $y = \pi(x)$. From the rectangle axiom for rectangles on the cycles $z_1 = z_3 = z_0$ and $z_2 = z$ we find (s. Fig 5.11) that \mathfrak{M} is symmetric to cycle z_0 . Lemma 5.29 shows $\pi^{-1} \in \Pi(z_0, E_0^-)$.

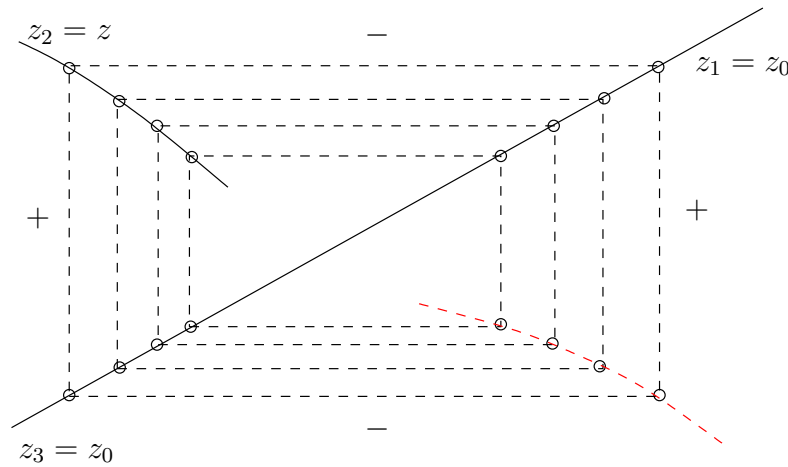

Figure 5.11: To proof of rectangle axiom: $b) \rightarrow a), II)$

I) and II) proves: $\Pi(z_0, E_0^-)$ is a group. □

5.5.4 The symmetry axiom

In Section 5.30 we characterized Minkowski-planes over groups by the rectangle axiom. Essentially the rectangle axiom is the geometric description of the closeness of the set $\Pi(z_0, E_0^-)$ of permutations of the corresponding Minkowski-plane. Applying Result 7.10 we get:

Set $\Pi(z_0, E_0^-)$ is a $PGL(2, K)$ over a suitable field K if and only if the following two statements hold:

(G_0) $\Pi(z_0, E_0^-)$ is a groups.

(I_0) Any permutation, that exchanges two points is an involution.

The geometrical meaning of property (I_0) is given by

Lemma 5.31 *Let be \mathfrak{M} a Minkowski-plane described by sets of permutations (s. Section 5.5.1). The following statements are equivalent.*

- (I₀) Any permutation of $\Pi(z_0, E_0^-)$, that exchanges two points is an involution.
- (S₀) Any cycle is symmetric to cycle z_0 if there is a pair of points symmetric to z_0 .

The proof is a direct consequence of the definition of $\Pi(z_0, E_0^-)$ and the definition of of a symmetry.

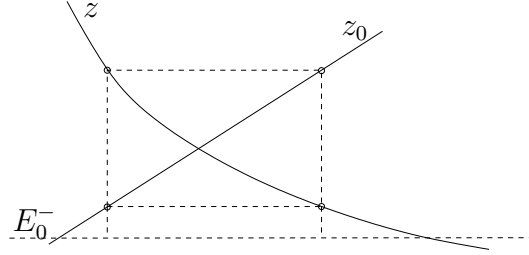

Figure 5.12: Symmetry axiom

Result 7.10 shows that properties (G₀) and (S₀) are equivalent to the Theorem of Miquel.

If we assume property (S₀) for any cycle z_0 of a Minkowski-plane, i.e. **symmetry axiom**

- (S) A cycle z_1 is symmetric to a cycle z_2 if there is a pair of points $P, Q \in z_1$ which is symmetric to z_2 .

is valid, then (G₀) can be deduced and \mathfrak{M} is miquelian.

The proof of this statement uses the following Lemma.

Lemma 5.32 Let be $\mathfrak{M} = (\mathcal{P}, \mathcal{Z}; \parallel_+, \parallel_-, \in)$ a Minkowski-plane with property (S).

- a) For a rectangle $[P, Q; R, S]$ (s. Section 5.5.3) and two cycles z_1, z_2 with $\sigma_{z_1}(P) = Q = \sigma_{z_2}(P)$ we get $z_1 \cap z_2 = \{R, S\}$.
- b) For a rectangle $[P, Q; R, S]$, two cycles $z_1 \neq z_2$ containing R, S and $X \in \mathcal{P} \setminus (\overline{P} \cup \overline{Q} \cup z_1 \cup z_2)$ there is exactly one cycle z' containing X which is symmetric to z_1 and z_2 . Additionally: $P, Q \in z'$.

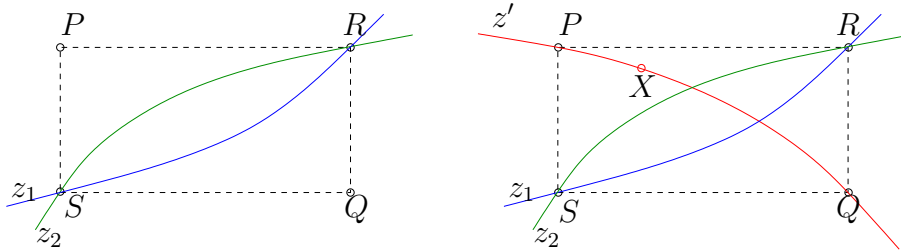

Figure 5.13: Consequences of the symmetry axiom: Lemma 5.32

Proof: a) is a consequence of the definition of a symmetry at a cycle.

b): Due to the preconditions: $X \neq \sigma_{z_1}(X) \neq \sigma_{z_2}(X)$. A cycle z' symmetric to z_1 and z_2 through X contains the points $X, \sigma_{z_1}(X), \sigma_{z_2}(X)$. Hence z' is uniquely determined. Obviously cycle z'' containing P, Q, X is symmetric to z_1 and z_2 , too. From the uniqueness we get $z' = z''$. \square

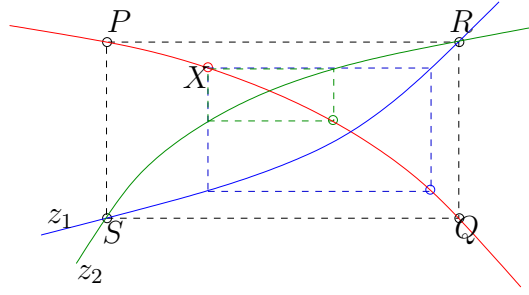

Figure 5.14: To proof of Lemma 5.32

Theorem 5.33 (Theorem of Artzy, [AR'73b]) *A Minkowski-plane \mathfrak{M} is miquelian if and only if \mathfrak{M} fulfills symmetry axiom (S).*

Proof: A) A *miquelian* Minkowski-plane \mathfrak{M} is isomorphic to a Minkowski-plane $\mathfrak{M}(K)$ (s. Section 5.3) and the automorphism group operates transitively on the set of cycles. Hence without loss of generality we prove (S) for the cycle z_2 with equation $y = x$. Two points P, Q symmetric to z_2 have coordinates $P = (x_0, y_0)$ and $Q = (y_0, x_0)$. In case of $P \in K^2$ a cycle z_1 containing P, Q has equation $y = -x + c$ or $y = \frac{a}{x-b} + b$. Obviously such a cycle is symmetric to cycle the $y = x$. In case of $P = (b, \infty)$ and $Q = (\infty, b)$ cycle z_1 has an equation $y = \frac{a}{x-b} + b$ and is symmetric to z_2 .

B) Minkowski-plane \mathfrak{M} has property (S). We describe \mathfrak{M} over a set of permutations (s. Section 5.5) and show in a first step that $\mathfrak{A}_{(\infty, \infty)}$ is pappian.

Let be E_1^+, E_2^+, E_3^+ and E_1^-, E_2^-, E_3^- three generators of \mathcal{E}^+ and \mathcal{E}^- , respectively, which do not contain point (∞, ∞) . Furthermore: Let be P_{ij} the point of intersection of E_i^+ and E_j^- ,

z_1 the cycle determined by $(\infty, \infty), P_{12}, P_{23}$,

z_2 the cycle determined by $(\infty, \infty), P_{21}, P_{32}$,

z_3 the cycle determined by $(\infty, \infty), P_{11}, P_{33}$.

Because of property (S) cycle z determined by P_{13}, P_{22}, P_{31} is symmetric to the cycles z_1, z_2 and z_3 , respectively, and vice versa. We shall show that the lines induced by z_1, z_2, z_3 in $\mathfrak{A}_{(\infty, \infty)}$ are either parallel or have a point in common.

In case of $(\infty, \infty) \in z$ we have $z_1 \cap z_2 = \{(\infty, \infty)\}$ because from $|z_1 \cap z_2| = 2$ and Lemma 5.32 we would get the contradiction $(\infty, \infty) \notin z$. Analogously we deduce $z_1 \cap z_2 = \{(\infty, \infty)\}$ and the lines induced in $\mathfrak{A}_{(\infty, \infty)}$ by z_1, z_2, z_3 are parallel (s. Fig. 5.15).

In case of $(\infty, \infty) \notin z$ the cycles z_1 and z_2 intersect in point $Q = \sigma_z((\infty, \infty))$, because z_1 and z_2 are symmetric to z . From $(\infty, \infty) \in z_3$ and the symmetry of z_3 with respect of z we get $Q \in z_3$.

For the following let be $g_1, g_2, g_3, h_1, h_2, h_3$ and l_1, l_2, l_3 the lines in $\mathfrak{A}_{(\infty, \infty)}$ induced by $E_1^+, E_2^+, E_3^+, E_1^-, E_2^-, E_3^-$ and z_1, z_2, z_3 . Let us consider this configuration of lines within the projective closure $\overline{\mathfrak{A}}_{(\infty, \infty)}$ of $\mathfrak{A}_{(\infty, \infty)}$. Hence in $\overline{\mathfrak{A}}_{(\infty, \infty)}$ we have proven the **Theorem**

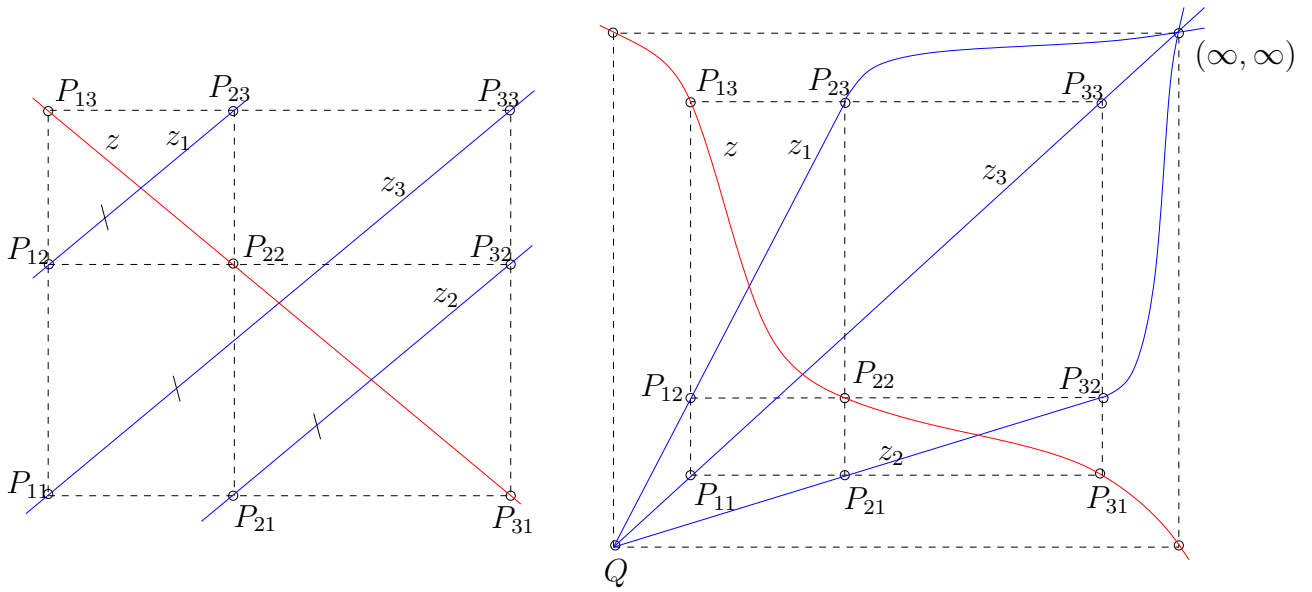

Figure 5.15: Proof of Theorem of Artzy

of Thomsen (which is the dual version of the Theorem of pappus) for two fixed bundles of lines and the projective plane $\overline{\mathfrak{A}}_{(\infty, \infty)}$ and hence the affine plane $\mathfrak{A}_{(\infty, \infty)}$ is pappian.

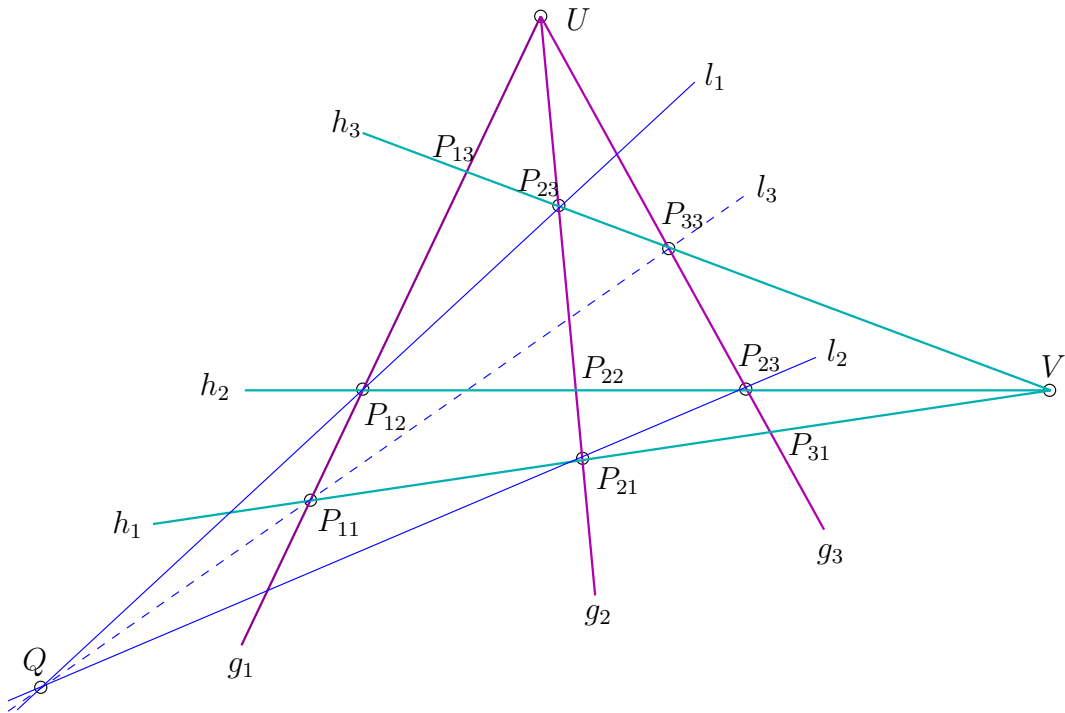

Figure 5.16: Proof of Theorem of Artzy: Theorem of Thomsen

The last step of the proof is to show that the cycles not containing (∞, ∞) are hyper-

bolas (conics) in $\mathfrak{A}_{(\infty, \infty)}$:

We coordinatize $\mathfrak{A}_{(\infty, \infty)}$ such that the lines induced by cycles have equations $y = ax + b$, $a \neq 0$.

A cycle not containing (∞, ∞) is uniquely determined by three points (b, ∞) , (∞, c) and $(b+1, c+a)$ with $a, b, c \in K$, $a \neq 0$. We describe z by a function f from $K \setminus \{b\}$ into $K \setminus \{c\}$ in the following way: $z = \{(x, y) \in K^2 \mid y = f(x), x \neq b\} \cup \{(b, \infty), (\infty, c)\}$. Because of (S) cycle z is symmetric to any cycle containing (∞, ∞) and (b, c) . Hence,

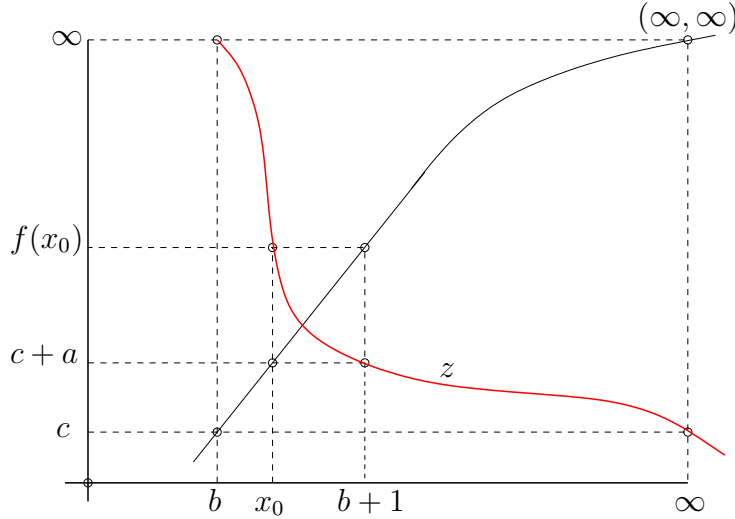

Figure 5.17: Proof of Theorem of Artzy: hyperbolas

for any $x_0 \in K \setminus \{b+1\}$ the points (b, c) , $(b+1, f(x_0))$ and $(x_0, c+a)$ are collinear and from $\frac{(c+a)-c}{x_0-b} = \frac{f(x_0)-c}{(b+1)-b}$ we get $f(x_0) = \frac{a}{x_0-b} + c$ for any $x_0 \in K \setminus \{b\}$. \square

5.5.5 Minkowski-planes of even order

For finite Minkowski-planes of *even* order the symmetry axiom (S) can be proven. With the Theorem of ARTZY (Theorem 5.33) we conclude: Any Minkowski-plane of even order is miquelian.

Lemma 5.34 (HEISE, KARZEL [HE,KA'73a], Satz 15) *Any Minkowski-plane of even order fulfills symmetry axiom (S).*

Proof: Let be z a cycle, P a point with $P \in z$ and z' a cycle containing P and $\sigma_z(P)$, where σ_z is the symmetry at cycle z (s. Section 5.5.4). Then $|z \cap z'| = 1$, because for $U = \overline{P} \cap z$ cycle z' induces in the projective closure $\overline{\mathfrak{A}}_U$ of the residue \mathfrak{A}_U an oval $\mathfrak{o}_U(z')$ (s. Theorem 5.4) with knot $K = \sigma_{z'}(U)$ and any line of $\overline{\mathfrak{A}}_U$ containing K is tangent to $\mathfrak{o}_U(z')$ (s. Theorem 2.26). Hence: $|z \cap z'| = 1$. Using the last statement we prove the symmetry axiom for $z_1 = z$ and $z_2 = z'$:

Let be $A = z \cap z'$, $W \in z \setminus \{U, K\}$ and z'' the cycle determined by the points $W, A, \sigma_{z'}(W)$.

Similar considerations (as above) show $|z'' \cap z'| = 1$. Hence z and z'' are tangent cycles to z' containing A and W . From the tangent cycle axiom we get $z = z''$ and $\sigma_{z'}(W) \in z'$. Because W was chosen arbitrarily out of $z \setminus \{U, K\}$ we conclude: z is symmetric to z' . \square

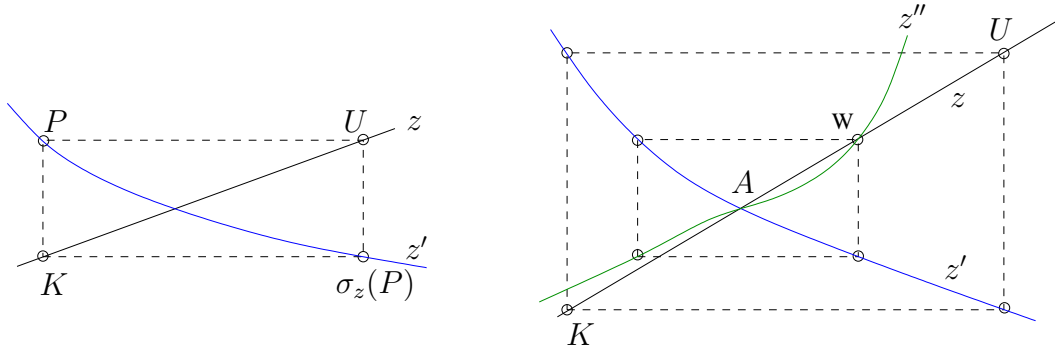

Figure 5.18: Proof of Theorem of Heise and Karzel

From Theorem 5.33 and Theorem 5.34 we get

Theorem 5.35 *Any Minkowski-plane of even order is miquelian.*

Different proofs of Theorem 5.35 can be found in [KA'78] and [BP'83].

5.6 Further Examples of Minkowski-planes

We shall introduce Minkowski-planes which cannot be represented over a TITS-nearfield, hence which do not fulfill axiom (G) (s. Section 5.5.2).

5.6.1 A method for the generation of finite Minkowski-planes

In Section 5.5 we saw that any Minkowski-plane corresponds to a sharply 3-transitive operating set of permutations acting on the set of a generator E_0^- . In the *finite* case the reversal statement is true, too.

Theorem 5.36 *Let be Π a set of permutations acting sharply 3-transitive on a finite set E , $|E| \geq 3$ and*

$$\mathcal{P} = E^2$$

$$\mathcal{Z} := \{ \{ (x, y) \in \mathcal{P} \mid y = \pi(x) \} \mid \pi \in \Pi \}$$

$$(x_1, y_1) \parallel_+ (x_2, y_2) \text{ iff } x_1 = x_2, \quad (x_1, y_1) \parallel_- (x_2, y_2) \text{ iff } y_1 = y_2.$$

Then $\mathfrak{M}(\Pi) := (\mathcal{P}, \mathcal{Z}; \parallel_+, \parallel_-, \in)$ is a Minkowski-plane.

Proof: One checks easily that $\mathfrak{M}(\Pi)$ fulfills axioms C1, C2, C3 and C5. In the finite case the tangent axiom can be deduced from the remaining axioms:

At first, one states that any generator and any cycle have the same number $n + 1 \geq 3$

of points and that for two non parallel points there are exactly $n - 1$ cycles containing these two points.

For the following let be P, P' and z defined as in axiom $C4$. Then z contains exactly $n - 2$ points different from P and not parallel to P' . Because of $C3$ exactly $n - 2$ cycles through P and P' meet z at 2 points. On the other hand we know that there are $n - 1$ cycles through P and P' . Hence there is exactly one cycle through P and P' which is tangent to z at point P . \square

Theorem 5.36 will be used in the next section.

5.6.2 Finite examples which do not fulfill (G)

Let be $(K, +, \cdot)$ the field with p^n elements with $p > 2$, $3 \leq n \in \mathbb{N}$, γ the automorphism $x \rightarrow x^p$ and Q the set of squares of K . Π is the following subset of the set of *semi*-linear mappings (s. Section 1.2.7)

$$\Pi = \{x \rightarrow \frac{ax+b}{cx+d} \mid a, b, c, d \in K, ad-bc \in Q\} \cup \{x \rightarrow \frac{a\gamma(x)+b}{c\gamma(x)+d} \mid a, b, c, d \in K, ad-bc \notin Q\}.$$

(Π operates on $K \cup \{\infty\}$.)

For $k_0 \in K \setminus Q$ and $\alpha_0 : x \rightarrow k_0\gamma(x)$ we have $\Pi = PSL(2, p^n) \cup PSL(2, p^n)\alpha_0$.

(Replacing γ by the identity we get $\Pi = PGL(2, p^n)$. For $n = 2$ set Π would be the sharply 3-transitive operating group over the nearfield $FK(p^2)$ (s. Section 7.5).)

Lemma 5.37 (PERCSY [PE'81]) Π operates sharply 3-transitive on $K \cup \{\infty\}$.

Proof: Group $PSL(2, p^n)$ and hence Π operates 2-transitively.

$\Pi_{0\infty} := \{x \rightarrow ax \mid 0 \neq a \in Q\} \cup \{x \rightarrow b\gamma(x) \mid b \notin Q\}$ is the subset of Π which fixes 0 and ∞ and operates sharply transitive (regular) on $K \setminus \{0\}$. Hence Π itself operates sharply 3-transitive. \square

Because of Theorem 5.36 there exists a corresponding Minkowski-plane which we abbreviate by $\mathfrak{M}(\Pi, p^n)$. Its automorphism group is rather large:

Lemma 5.38 For the Minkowski-plane $\mathfrak{M}(\Pi, p^n)$ the following mappings are automorphisms (of the incidence structure $(\mathcal{P}, \mathcal{Z}, \in)$):

$$(x, y) \rightarrow (y, x) \quad \text{and} \quad (x, y) \rightarrow (\tau_1(x), \tau_2(y)), \quad \tau_1, \tau_2 \in PSL(2, p^n).$$

Proof: The proof results from the two properties:

$$(1) PSL(2, p^n) \text{ is a group,} \quad (2) PSL(2, p^n)\alpha_0 = \alpha_0 PSL(2, p^n). \quad \square$$

Remark 5.8 In case of $p^n \equiv 1 \pmod{4}$ element -1 is a square and the mapping $x \rightarrow -x$ is contained in $PSL(2, p^n)$. Hence the reflections at generators $(x, y) \rightarrow (-x, y)$ and $(x, y) \rightarrow (x, -y)$ are automorphisms of $\mathfrak{M}(\Pi, p^n)$.

5.6.3 Real examples, which do not fulfill (G)

We start from the classical real Minkowski-plane, i.e. $\mathcal{P} = (\mathbb{R} \cup \{\infty\})^2$, and replace the cycles $\mathcal{Z}_0 := \{\{(x, y) \in \mathcal{P} \mid y = \pi(x)\} \mid \pi \in PGL(2, \mathbb{R})\}$ by the system $\mathcal{Z}_1(f)$ and $\mathcal{Z}_2(f)$, respectively, of curves.

Definition 5.10 Let be f a monotone increasing bijection of \mathbb{R} onto itself with $f(0) = 0$, $f(1) = 1$ and \bar{f} the bijection of $\mathbb{R} \cup \{\infty\}$ with $\bar{f}(\infty) = \infty$ and $\bar{f}(x) = f(x)$ for $x \in \mathbb{R}$. Using $\Pi := PSL(2, \mathbb{R}) \cup PSL(2, \mathbb{R}) \cdot (-\bar{f})$ we define

$$\begin{aligned} \mathcal{Z}_1(f) &:= \{\{(x, y) \in \mathcal{P} \mid y = \pi(x)\} \mid \pi \in \Pi\} \\ &= \{\{(x, y) \in \mathbb{R}^2 \mid y = ax + b\} \cup \{(\infty, \infty)\} \mid a, b \in \mathbb{R}, a > 0\} \\ &\quad \cup \{\{(x, y) \in \mathbb{R}^2 \mid y = af(x) + b\} \cup \{(\infty, \infty)\} \mid a, b \in \mathbb{R}, a < 0\} \\ &\quad \cup \{\{(x, y) \in \mathbb{R}^2 \mid y = \frac{a}{x-b} + c, x \neq b\} \cup \{(b, \infty), (\infty, c)\} \mid a, b, c \in \mathbb{R}, a < 0\} \\ &\quad \cup \{\{(x, y) \in \mathbb{R}^2 \mid y = \frac{a}{f(x)-f(b)} + c, x \neq b\} \cup \{(b, \infty), (\infty, c)\} \mid a, b, c \in \mathbb{R}, a > 0\} \end{aligned}$$

Alike the classical model we define $\mathfrak{M}_1(f) := (\mathcal{P}, \mathcal{Z}_1(f), \in, \parallel_+, \parallel_-)$. It is easy to find automorphisms of $\mathfrak{M}_1(f)$:

Lemma 5.39 Any mapping $(x, y) \rightarrow (x, \tau(y))$, with $\tau \in PSL(2, \mathbb{R})$, is an automorphism of $\mathfrak{M}_1(f)$.

The proof is based on the fact that $PSL(2, \mathbb{R})$ is a group.

With help of Lemma 5.39 we prove the following theorem.

Theorem 5.40 (SCHENKEL, [SC'80]) $\mathfrak{M}_1(f)$ is a Minkowski-plane.

Proof: Because of Lemma 5.39 it is sufficient to prove that the residue $\mathfrak{A}_{(x_0, \infty)}$ at any point (x_0, ∞) is an affine plane. In case of $x_0 = \infty$ the prove is obvious.

In case of $x_0 = b \neq \infty$ one maps $\mathfrak{A}_{(x_0, \infty)}$ by $(x, y) \rightarrow (-\frac{1}{x-b}, y)$ onto \mathbb{R}^2 . The images of the curves will be described by $y = ax + b, a > 0$ and $y = ah(x) + b, a < 0$ and $x = c, y = d$, respectively, where h is a monotone increasing bijection of \mathbb{R} . Such an incidence structure is (like the case $\mathfrak{A}_{(\infty, \infty)}$) an affine plane. \square

Remark 5.9 a) $\mathfrak{M}_1(f)$ is miquelian if $f(x) = x$.

b) In non miquelian case any residue of $\mathfrak{M}_1(f)$ is a non desarguesian affine plane.

c) Topological properties were explored by Schenkel in [SC'80].

d) In case of $f \neq$ identity the Minkowski-plane $\mathfrak{M}_1(f)$ does not fulfill axiom (G).

Definition 5.11 Let be $g(x) := \begin{cases} \frac{1}{x^m} & \text{for } x > 0 \\ -\frac{1}{|x|^n} & \text{for } x < 0, \end{cases}$ with $0 < m, n \in \mathbb{R}$ fixed.

Definition 5.12 $\mathcal{Z}_2(g) := \{ \{(x, y) \in \mathbb{R}^2 \mid y = ax + b\} \cup \{(\infty, \infty)\} \mid a, b \in \mathbb{R}, a \neq 0\} \\ \cup \{ \{(x, y) \in \mathbb{R}^2 \mid y = ag(x-b)+c, x \neq b\} \cup \{(b, \infty), (\infty, c)\} \mid a, b, c \in \mathbb{R}, a \neq 0\}$

Analogously we define $\mathfrak{M}_2(g) := (\mathcal{P}, \mathcal{Z}_2(g), \in, \parallel_+, \parallel_-)$.

Result 5.41 (HARTMANN [HA'81a]) $\mathfrak{M}_2(g)$ is a Minkowski-plane.

Remark 5.10 a) $MF_2(g)$ is miquelian if and only if $m = n = 1$, i.e. $g(x) = \frac{1}{x}$.

b) In non miquelian case $\mathfrak{M}_2(g)$ does not fulfill axiom (G).

c) In [SC'80] Schenkel discussed these examples from a topological aspect.

5.7 Automorphisms of Minkowski-planes

We repeat the definition of an automorphism of a Minkowski-plane:

Definition 5.13 Let be $\mathfrak{M} = (\mathcal{P}, \mathcal{Z}; \parallel_+, \parallel_-, \in)$ a Minkowski-plane. Any automorphism of the incidence structure $(\mathcal{P}, \mathcal{Z}, \in)$ is called **automorphism of the Minkowski-plane**.

There are automorphisms of a Minkowski-plane with special meanings:

Definition 5.14 Any automorphism of a Minkowski-plane $\mathfrak{M} = (\mathcal{P}, \mathcal{Z}; \parallel_+, \parallel_-, \in)$

a) that fixes two non parallel points P, Q and any cycle through P, Q is called **dilatation at P, Q** .

Denotation of the group of such dilatations: $\Delta(P, Q)$.

b) that fixes two generators $E_1^+, E_2^+ \in \mathcal{E}^+$ ($E_1^-, E_2^- \in \mathcal{E}^-$) pointwise is called **dilatation at E_1^+, E_2^+ (dilatation at E_1^-, E_2^-)**.

Denotation of the group of such dilatations: $\Delta(E_1^+, E_2^+)$ and $\Delta(E_1^-, E_2^-)$.

c) that fixes exactly one generator $E^+ \in \mathcal{E}^+$ or \mathcal{P} ($E^+ \in \mathcal{E}^+$ or \mathcal{P}) pointwise is called **translation with axis E^+ (E^-)**.

Denotation of the group of such translations: $T(E^+)$ and $T(E^-)$.

The following is true:

Lemma 5.42 a) Any $\bar{\delta} \in \Delta(P, Q)$ induces a dilatation in \mathfrak{A}_P and \mathfrak{A}_Q at a point ([HA'82b], 2.1).

b) Any $\bar{\delta} \in \Delta(E_1^+, E_2^+)$ induces in any \mathfrak{A}_P with $P \in E_1^+ \cup E_2^+$ a dilatation at a line. (Analogously for $\Delta(E_1^-, E_2^-)$.)

c) Any $\bar{\tau} \in T(E^+)$ induces in any \mathfrak{A}_P with $P \in E^+$ a translation. (Analogously for $T(E^-)$.)

- Definition 5.15** a) A group $\Delta(P, Q)$ is called **circular transitive** if its restriction onto \mathfrak{A}_P (or \mathfrak{A}_Q) is linear transitive.
- b) A group $\Delta(E_1^+, E_2^+)$ or $\Delta(E_1^-, E_2^-)$ or $T(E^+)$ or $T(E^-)$, respectively, is called **circular transitive** if its restriction on a residue \mathfrak{A}_P of a fixed point P is linear transitive.

For involutions we give the following definition:

- Definition 5.16** An involutorial automorphism of a Minkowski-plane $\mathfrak{M} = (\mathcal{P}, \mathcal{Z}; \parallel_+, \parallel_-, \in)$
- a) that fixes exactly one rectangle $[P, Q; R, S]$ (s. Section 5.5.3) pointwise is called **reflection at rectangle** $[P, Q; R, S]$.
- b) that fixes a cycle z pointwise is called **reflection at cycle** z .
- c) that fixes a generator E pointwise is called **reflection at generator** E .

The next lemma clarifies the connection between reflections and involutorial dilatations.

- Lemma 5.43** a) A reflection at a rectangle $[P, Q; R, S]$ is a dilatation at P, R and Q, S .
- b) An involutorial dilatation at two (non parallel) points P, R is a reflection at rectangle $[P, Q; R, S]$ with $Q = \overline{P}_- \cap \overline{R}_+$ and $S = \overline{P}_+ \cap \overline{R}_-$.
- c) An automorphism of a Minkowski-plane that fixes a cycle pointwise is the identity or the (unique) reflection at z .

Proof: a) Reflection $\overline{\sigma}$ at rectangle $[P, Q; R, S]$ induces in residue \mathfrak{A}_P an involutorial collineation σ with single fixpoint R . From [HU,PI'73], pages 91,92 we know that σ is a reflection (involutorial dilatation) at point R . Hence $\overline{\sigma}$ is a reflection at the points P, R . Analogously: $\overline{\sigma}$ is a reflection at the points Q, S , too.

b) Let be $\overline{\delta}$ an involutorial dilatation at P, R . Then points P, Q with $\{Q\} := \overline{P}_- \cap \overline{R}_+$ and $\{S\} := \overline{P}_+ \cap \overline{R}_-$ are the sole further fixpoints of $\overline{\delta}$. Hence $\overline{\delta}$ is the reflection at rectangle $[P, Q; R, S]$.

c) Let be $\overline{\psi} \neq id$ an automorphism of a Minkowski-plane which fixes a cycle pointwise. $\overline{\psi}$ exchanges \mathcal{E}^+ and \mathcal{E}^- . Otherwise, $\overline{\psi}$ would induce a central collineation with two centers in the projective closure $\overline{\mathfrak{A}}_P, P \in z$ of \mathfrak{A}_P . One easily checks that $\overline{\psi}$ is the symmetry at cycle z (s. Section 5.5.3) and hence the reflection at z . \square

Below we assemble some properties considering transitivity and reflections of Minkowski-planes over TITS-nearfields and miquelian Minkowski-planes, respectively.

Lemma 5.44 Let be $\mathfrak{M} = (\mathcal{P}, \mathcal{Z}; \parallel_+, \parallel_-, \in)$ a Minkowski-plane over a TITS-nearfield. Then

- a) any group $\Delta(E_1^+, E_2^+)$ and $\Delta(E_1^-, E_2^-)$, respectively, of dilatations at two generators is circular transitive.
- b) any group $T(E^+)$ and $T(E^-)$, respectively, of translations is circular transitive.
- c) for any cycle there is a reflection.
- d) for any three generators $E_0^+, E_1^+, E_2^+ \in \mathcal{E}^+$ ($E_0^-, E_1^-, E_2^- \in \mathcal{E}^-$) there is exactly one reflection at E_0^+ (E_0^-) which exchanges E_1^+ with E_2^+ (E_1^- with E_2^-).
- e) in case of characteristic $\neq 2$ for any rectangle there is exactly one reflection.

Lemma 5.45 *A miquelian Minkowski-plane \mathfrak{M} additionally fulfills:*

- f) Any group $\Delta(P, Q)$ of dilatations at two points is circular transitive.

The proofs of these statements are performed easily with help of the automorphisms of a Minkowski-plane $\mathfrak{M}(K, f)$ and $\mathfrak{M}(K)$, respectively, (s. Lemma 5.25 and Lemma 5.8). The following results show which properties are typical for Minkowski-planes over TITS-nearfields.

Result 5.46 (ARTZY [AR'77], PERCSY [PE'79]) *For a Minkowski-plane \mathfrak{M} the following statements are equivalent:*

- a) \mathfrak{M} can be described over a TITS-nearfield (s. Section 5.4).
- b) Any group $\Delta(E_1^+, E_2^+)$ of dilatations is circular transitive.
- c) Any group $\Delta(E_1^-, E_2^-)$ of dilatations is circular transitive.

Properties b) and c) can be weakened (s. [HA'82a]).

Result 5.47 (PERCSY [PE'81], HARTMANN [HA'81b]) *A finite Minkowski-plane \mathfrak{M} can be described over a TITS-nearfield if and only if for any cycle there is a reflection.*

(In case of even order \mathfrak{M} is miquelian, anyway (s. Theorem 5.35) !)

For miquelian Minkowski-planes we have

Result 5.48 (HARTMANN [HA'82a]) *A Minkowski-plane \mathfrak{M} is miquelian if and only if any group $\Delta(P, Q)$ of dilatations at pairs of points is circular transitive.*

Result 5.49 (DIENST [DI'77], HARTMANN [HA'81b]) *A minkowski-plane is miquelian if and only if:*

- (i) For any cycle there is a reflection.
- (ii) For any two non parallel points P, Q and any three cycles z_1, z_2, z_3 through P, Q the product of the reflections at z_1, z_2, z_3 is a reflection at a cycle z_4 through P, Q (Theorem of three reflections).

Chapter 6

Appendix: Quadrics in projective spaces

We shall restrict ourself to the case of *finite dimensional* projective spaces. Essential for plane circle geometries (Möbius-, Laguerre- and Minkowski-planes) are oval conics (dimension 2) and sphere, cone and hyperboloid (dimension 3) only.

6.1 Quadratic forms

Let be K a field and $\mathcal{V}(K)$ a vector space over K . A mapping ρ from $\mathcal{V}(K)$ in K with

(Q1) $\rho(x\mathbf{x}) = x^2\rho(\mathbf{x})$ for any $x \in K$ and $\mathbf{x} \in \mathcal{V}(K)$.

(Q2) $f(\mathbf{x}, \mathbf{y}) := \rho(\mathbf{x} + \mathbf{y}) - \rho(\mathbf{x}) - \rho(\mathbf{y})$ is a bilinear form.

is called **quadratic form**. (f is even *symmetric!*)

In case of $\text{char}K \neq 2$ we have $f(\mathbf{x}, \mathbf{x}) = 2\rho(\mathbf{x})$, i.e. f and ρ are mutually determined in a unique way.

In case of $\text{char}K = 2$ we have always $f(\mathbf{x}, \mathbf{x}) = 0$, i.e. f is *symplectic*.

For $\mathcal{V}(K) = K^n$ and $\mathbf{x} = \sum_{i=1}^n x_i \mathbf{e}_i$ ($\{\mathbf{e}_1, \dots, \mathbf{e}_n\}$ is a base of $\mathcal{V}(K)$) ρ has the form

$$\rho(\mathbf{x}) = \sum_{1=i \leq k}^n a_{ik} x_i y_k \quad \text{with } a_{ik} := f(\mathbf{e}_i, \mathbf{e}_k) \text{ for } i \neq k \text{ and } a_{ik} := \rho(\mathbf{e}_i) \text{ for } i = k \text{ and}$$

$$f(\mathbf{x}, \mathbf{y}) = \sum_{1=i \leq k}^n a_{ik} (x_i y_k + x_k y_i).$$

For example: $n = 3$, $\rho(\mathbf{x}) = x_1 x_2 - x_3^2$, $f(\mathbf{x}, \mathbf{y}) = x_1 y_2 + x_2 y_1 - 2x_3 y_3$.

6.2 Definition and properties of a quadric

Below let be K a field, $2 \leq n \in \mathbb{N}$ and $\mathfrak{P}_n(K) = (\mathcal{P}, \mathcal{Z}, \in)$ the n -dimensional projective space over K , i.e.

$\mathcal{P} = \{ \langle \mathbf{x} \rangle \mid \mathbf{0} \neq \mathbf{x} \in K^{n+1} \}$ the set of points

($\langle \mathbf{x} \rangle$ is the 1-dimensional subspace generated by \mathbf{x}),

$\mathcal{G} = \{ \{ \langle \mathbf{x} \rangle \in \mathcal{P} \mid \mathbf{x} \in U \} \mid U \text{ 2-dim. subspace of } K^{n+1} \}$ the set of lines.

Additionally let be ρ a quadratic form on vector space K^{n+1} . A point $\langle \mathbf{x} \rangle \in \mathcal{P}$ is called **singular** if $\rho(\mathbf{x}) = 0$. The set

$\mathcal{Q} = \{ \langle \mathbf{x} \rangle \in \mathcal{P} \mid \rho(\mathbf{x}) = 0 \}$ of singular points of ρ is called **quadric** (with respect to the quadratic form ρ).

For point $P = \langle \mathbf{p} \rangle \in \mathcal{P}$ the set $P^\perp := \{ \langle \mathbf{x} \rangle \in \mathcal{P} \mid f(\mathbf{p}, \mathbf{x}) = 0 \}$ is called **polar space** of P (with respect of ρ). Obviously P^\perp is either a hyperplane or \mathcal{P} .

For the considerations below we assume: $\mathcal{Q} \neq \emptyset$.

Example 6.1 For $\rho(\mathbf{x}) = x_1x_2 - x_3^2$ we get an oval conic in $\mathfrak{P}_2(K)$. (s. Section 2.4).

For the intersection of a line with a quadric \mathcal{Q} we get:

Lemma 6.1 For a line g (of $\mathfrak{P}_n(K)$) the following cases occur:

- a) $g \cap \mathcal{Q} = \emptyset$ and g is called **exterior line** or
- b) $g \subset \mathcal{Q}$ and g is called **tangent line** or
- b') $|g \cap \mathcal{Q}| = 1$ and g is called **tangent line** or
- c) $|g \cap \mathcal{Q}| = 2$ and g is called **secant line**.

Proof:

Let be $g \cap \mathcal{Q} \neq \emptyset$ and $P := \langle \mathbf{p} \rangle \in g \cap \mathcal{Q}$, $Q := \langle \mathbf{q} \rangle \in g \setminus \{P\}$. From $\rho(\mathbf{p}) = 0$ we get $\rho(x\mathbf{p} + \mathbf{q}) = \rho(x\mathbf{p}) + \rho(\mathbf{q}) + f(x\mathbf{p}, \mathbf{q}) = \rho(\mathbf{q}) + xf(\mathbf{p}, \mathbf{q})$.

I) In case of $g \subset P^\perp$ we have $f(\mathbf{p}, \mathbf{q}) = 0$ and $\rho(x\mathbf{p} + \mathbf{q}) = \rho(\mathbf{q})$ for any $x \in K$. Hence either $\rho(x + \mathbf{p} + \mathbf{q}) = 0$ for any $x \in K$ or $\rho(x + \mathbf{p} + \mathbf{q}) \neq 0$ for any $x \in K$.

II) In case of $g \not\subset P^\perp$ we have $f(\mathbf{p}, \mathbf{q}) \neq 0$ and the equation $\rho(x\mathbf{p} + \mathbf{q}) = \rho(\mathbf{q}) + xf(\mathbf{p}, \mathbf{q}) = 0$ has exactly one solution x . Hence: $|g \cap \mathcal{Q}| = 2$.

I) and II) proves Lemma 6.1. □

The following statement is a further consequence of the proof of Lemma 6.1.

Lemma 6.2 A line g through point $P \in \mathcal{Q}$ is a tangent line if and only if $g \subset P^\perp$.

Lemma 6.3 a) $\mathcal{R} := \{ P \in \mathcal{P} \mid P^\perp \}$ is a (projective) subspace. \mathcal{R} is called **f-radical** of quadric \mathcal{Q} .

b) $\mathcal{S} := \mathcal{R} \cap \mathcal{Q}$ is a (projective) subspace. \mathcal{S} is called **singular radical** or ρ -**radical** of \mathcal{Q} .

c) In case of $\text{char}K \neq 2$ we have $\mathcal{R} = \mathcal{S}$.

Proof: a) Let be $P \neq Q \in \mathcal{R}$ with $P := \langle \mathbf{p} \rangle, Q := \langle \mathbf{q} \rangle$. From $f(\mathbf{p}, \mathbf{x}) = f(\mathbf{q}, \mathbf{x}) = 0$ for any \mathbf{x} we get $f(a\mathbf{p} + b\mathbf{q}, \mathbf{x}) = af(\mathbf{p}, \mathbf{x}) + bf(\mathbf{q}, \mathbf{x}) = 0$ for any \mathbf{x} and $a, b \in K$. Hence: line \overline{PQ} is contained in \mathcal{R} .

b) Let be $P \neq Q \in \mathcal{R} \cap \mathcal{Q}$ and $P := \langle \mathbf{p} \rangle, Q := \langle \mathbf{q} \rangle$. From $f(\mathbf{p}, \mathbf{x}) = f(\mathbf{q}, \mathbf{x}) = 0$ for any \mathbf{x} and $\rho(\mathbf{p}) = \rho(\mathbf{q}) = 0$ we get $f(a\mathbf{p} + b\mathbf{q}, \mathbf{x}) = 0$ for any \mathbf{x} and $a, b \in K$. Furthermore: $\rho(a\mathbf{p} + b\mathbf{q}) = \rho(a\mathbf{p}) + \rho(b\mathbf{q}) + f(a\mathbf{p}, b\mathbf{q}) = 0$ for any $a, b \in K$. Hence: line \overline{PQ} is contained in \mathcal{S} .

c) In case of $\text{char}K \neq 2$ we have $\mathcal{R} \subset \mathcal{Q}$ due to $f(\mathbf{x}, \mathbf{x}) = 2\rho(\mathbf{x})$. \square

A quadric is called **non degenerated** if $\mathcal{S} = \emptyset$.

Remark 6.1 An oval conic (s. Section 2.4) is a non degenerated quadric. In case of $\text{char}K = 2$ its knot is the f -radical, i.e. $\emptyset = \mathcal{S} \neq \mathcal{R}$. (s. examples at the end of this section.)

The restriction of a quadratic form onto a subspace U of K^{n+1} is a quadratic form on U , too. Hence

Lemma 6.4 For any (projective) subspace \mathcal{U} of $\mathfrak{P}_n(K)$ set $\mathcal{U} \cap \mathcal{Q}$ is a quadric of \mathcal{U} .

Lemma 6.5 Let be $\mathcal{S} \neq \emptyset$ and \mathcal{C} a complement of \mathcal{S} (in $\mathfrak{P}_n(K)$). Then

a) $\mathcal{Q}' := \mathcal{C} \cap \mathcal{Q}$ is a non degenerated quadric.

$$b) \mathcal{Q} = \bigcup_{S \in \mathcal{S}, Q' \in \mathcal{Q}'} \overline{SQ'}.$$

Proof: a) is easily checked.

b) Let be $P \in \mathcal{Q} \setminus \mathcal{S}, S \in \mathcal{S}$. Hence $S \in P^\perp$ and, due to Lemma 6.2 we have $\overline{PS} \subset \mathcal{Q}$ and $\overline{PS} \cap \mathcal{C} \neq \emptyset$. For $Q' := \overline{PS} \cap \mathcal{C}$ we get $P \in \overline{SQ'}$. \square

We conclude: A quadric \mathcal{Q} is uniquely determined by its ρ -radical \mathcal{S} (a subspace) and its part \mathcal{Q}' (a non degenerated quadric) in a complement \mathcal{C} of \mathcal{S} .

Lemma 6.6 a) In case of $\mathcal{Q} = \mathcal{S}$ quadric \mathcal{Q} is a subspace of $\mathfrak{P}_n(K)$.

b) In case of $\mathcal{Q} \neq \mathcal{S}$ pointset \mathcal{P} of $\mathfrak{P}_n(K)$ is the smallest subspace that contains \mathcal{Q} .

Proof: a) is a consequence of Lemma 6.3.

b) For $P \in \mathcal{Q} \setminus \mathcal{S}$ set P^\perp is a hyperplane and any line through P which is not contained in P^\perp is a secant line of \mathcal{Q} . If there would exist a subspace $\mathcal{U} \neq \mathcal{P}$ that contains \mathcal{Q} then all secants through P should be contained in \mathcal{U} . This is impossible. \square

A quadric is a rather homogeneous object:

Lemma 6.7 For any point $P \in \mathcal{P} \setminus (\mathcal{Q} \cup \mathcal{R})$ there exists an involutorial central collineation σ_P with center P and $\sigma_P(\mathcal{Q}) = \mathcal{Q}$.

Proof: Due to $P \in \mathcal{P} \setminus (\mathcal{Q} \cup \mathcal{R})$ the polar space P^\perp is a hyperplane.

The linear mapping $\varphi : \mathbf{x} \rightarrow \mathbf{x} + \frac{f(\mathbf{p}, \mathbf{x})}{\rho(\mathbf{p})} \mathbf{p}$ induces an involutorial central collineation with axis P^\perp and centre P which leaves \mathcal{Q} invariant.

In case of $\text{char} K \neq 2$ mapping φ gets the familiar shape $\varphi : \mathbf{x} \rightarrow \mathbf{x} - 2 \frac{f(\mathbf{p}, \mathbf{x})}{f(\mathbf{p}, \mathbf{p})} \mathbf{p}$ with $\varphi(\mathbf{p}) = -\mathbf{p}$ and $\varphi(\mathbf{x}) = \mathbf{x}$ for any $\langle \mathbf{x} \rangle \in P^\perp$. \square

Remark 6.2 a) The image of an exterior, tangent and secant line, respectively, by the involution σ_P of Lemma 6.7 is an exterior, tangent and secant line, respectively.

b) \mathcal{R} is pointwise fixed by σ_P .

Let be $\Pi(\mathcal{Q})$ the group of projective collineations of $\mathfrak{P}_n(K)$ which leaves \mathcal{Q} invariant. Due to Lemma 6.7 we get

Lemma 6.8 $\Pi(\mathcal{Q})$ operates transitively on $\mathcal{Q} \setminus \mathcal{R}$.

Proof: Let be $A \neq B \in \mathcal{Q} \setminus \mathcal{R}$.

I) If \overline{AB} is a secant line then there exists a point $P \in \overline{AB} \setminus (\mathcal{Q} \cup \mathcal{R})$. Using Lemma 6.7 we get the statement of the present Lemma.

II) If \overline{AB} is a tangent line then $\overline{AB} \subset \mathcal{Q}$ and A^\perp, B^\perp are hyperplanes. Because of Lemma 6.2 we find a point $Q \in \mathcal{Q} \setminus (A^\perp \cup B^\perp)$ and the lines \overline{AQ} and \overline{BQ} are secant lines. Applying I) (first on A, Q and then on Q, B) we get the statement above. \square

A subspace \mathcal{U} of $\mathfrak{P}_n(K)$ is called ρ -subspace if $\mathcal{U} \subset \mathcal{Q}$ (for example: points on a sphere or lines on a hyperboloid (s. below)).

Lemma 6.9 Any two maximal ρ -subspaces have the same dimension m .

Proof: Let be $\mathcal{U}_1, \mathcal{U}_2$ be maximal ρ -subspaces. From Lemma 6.5 we derive $\mathcal{S} \subset \mathcal{U}_1 \cap \mathcal{U}_2$ and in case of $\mathcal{Q} = \mathcal{S}$ we get $\mathcal{U}_1 = \mathcal{U}_2 = \mathcal{S}$, in case of $\mathcal{Q} \neq \mathcal{S}$ we prove the statement by induction:

I) For $n = 1$ the quadric \mathcal{Q} consists of two points in $\mathfrak{P}_1(K)$ and the statement is true.

II) Let be $n > 1$ and the statement true for dimension $< n$. For maximal ρ -subspaces $\mathcal{U}_1, \mathcal{U}_2$ we have $\mathcal{S} \subset \mathcal{U}_1 \cap \mathcal{U}_2$ and because of $\mathcal{Q} \neq \mathcal{S}$ there exist points $P_1 \in \mathcal{U}_1 \setminus \mathcal{S}$ and $P_2 \in \mathcal{U}_2 \setminus \mathcal{S}$. From Lemma 6.8 we know that there exists a ρ -subspace \mathcal{U}'_2 such that $P_1 \in \mathcal{U}'_2$ and $\dim \mathcal{U}'_2 = \dim \mathcal{U}_2$. Both \mathcal{U}_1 and \mathcal{U}'_2 are contained in the hyperplane P_1^\perp . The set $\mathcal{Q}' := \mathcal{Q} \cap P_1^\perp$ is a non degenerate quadric. Let be ρ' the quadratic form of \mathcal{Q}' . $\mathcal{U}_1, \mathcal{U}'_2$ are maximal ρ' -subspaces. If $\mathcal{Q}' = \mathcal{S}'$ ($:= \rho'$ -radical) the statement is obvious. If $\mathcal{Q}' \neq \mathcal{S}'$ the statement is a consequence of the assumption for the induction. \square

Let be m the dimension of the maximal ρ -subspaces of \mathcal{Q} . The integer $i := m + 1$ is called **index of \mathcal{Q}** .

Result 6.10 (BUEKENHOUT [BU'69]) For the index i of a non degenerate quadric \mathcal{Q} in $\mathfrak{P}_n(K)$ the following is true: $i \leq \frac{n+1}{2}$.

Definition 6.1 Let be \mathcal{Q} a non degenerate quadric in $\mathfrak{P}_n(K)$, $n \geq 2$, and i its index. In case of $i = 1$ quadric \mathcal{Q} is called **sphere** (or oval conic if $n = 2$). In case of $n = 2$ quadric \mathcal{Q} is called **hyperboloid** (of one sheet).

Example 6.2 a) Quadric \mathcal{Q} in $\mathfrak{P}_2(K)$ with form $\rho(\mathbf{x}) = x_1x_2 - x_3^2$ is non degenerated with index 1.

Proof: The corresponding bilinear form is $f(\mathbf{x}, \mathbf{y}) = x_1y_2 + x_2y_1 - 2x_3y_3$. One easily checks that in case of $\text{char}K = 2$ only f -radical \mathcal{R} is not empty: $\mathcal{R} = \langle (0, 0, 1) \rangle$ and $\mathcal{S} = \mathcal{R} \cap \mathcal{Q} = \emptyset$. Hence in any case \mathcal{Q} is non degenerated. The tangent P_0^\perp at point $P_0 := \langle (1, 0, 0) \rangle \in \mathcal{Q}$ has equation $x_2 = 0$ and $P_0^\perp \cap \mathcal{Q} = \{P_0\}$. Because of Lemma 6.8 for any point $P \in \mathcal{Q}$ we have $P^\perp \cap \mathcal{Q} = \{P\}$, i.e. index of \mathcal{Q} is 1. \square

b) If polynomial $q(\xi) = \xi^2 + a_0\xi + b_0$ is irreducible over K the quadratic form $\rho(\mathbf{x}) = x_1^2 + a_0x_1x_2 + b_0x_2^2 - x_3x_4$ gives rise of a non degenerated quadric \mathcal{Q} in $\mathfrak{P}_3(K)$.

Proof: The corresponding bilinear form is

$$f(\mathbf{x}, \mathbf{y}) = 2x_1y_1 + a_0(x_1y_2 + x_2y_1) + 2b_0x_2y_2 - x_3y_4 - x_4y_3.$$

In case of “ q separable” (s. Section 3.3) we have $4b_0 - a_0^2 \neq 0$ and one easily checks: $\mathcal{R} = \emptyset$.

Case “ q inseparable” is possible only if $a_0 = 0$, $\text{char}K = 2$ and b_0 is not a square. In this case we have $\mathcal{R} = \{ \langle (s, t, 0, 0) \rangle \mid s, t \in K, (s, t) \neq (0, 0) \}$ and $\mathcal{S} = \mathcal{R} \cap \mathcal{Q} = \emptyset$.

Hence in any case \mathcal{Q} is non degenerated.

Like case a) we conclude: The index of \mathcal{Q} is 1, i.e. \mathcal{Q} is a sphere. \square

c) In $\mathfrak{P}_3(K)$ the quadratic form $\rho(\mathbf{x}) = x_1x_2 + x_3x_4$ gives rise of a hyperboloid.

Proof: The corresponding bilinear form is $f(\mathbf{x}, \mathbf{y}) = x_1y_2 + x_2y_1 + x_3y_4 + x_4y_3$ and $\mathcal{R} = \emptyset$, i.e. \mathcal{Q} is non degenerated. The tangent plane P_0^\perp at point

$P_0 := \langle (1, 0, 0, 0) \rangle$ has equation $x_2 = 0$ and we get

$$P_0^\perp \cap \mathcal{Q} = \{ \langle \mathbf{x} \rangle \in \mathcal{P} \mid x_3 = 0 \} \cup \{ \langle \mathbf{x} \rangle \in \mathcal{P} \mid x_4 = 0 \}.$$

Hence a maximal ρ -subspace has dimension 1, i.e. the index of quadric \mathcal{Q} is 2. \square

Remark 6.3 Let be \mathcal{Q} an arbitrary sphere (hyperboloid) in $\mathfrak{P}_3(K)$. We introduce new coordinates x'_1, x'_2, x'_3, x'_4 such that the corresponding quadratic form becomes shape b) (c), respectively) above. Hence there exists (until equivalence) exactly one hyperboloid in $\mathfrak{P}_3(K)$. In general the statement for spheres is not true; but in case of $\text{char}K \neq 2$ it can be achieved that $a_0 = 0$.

6.3 Quadratic sets

In [BU'69] BUEKENHOUT introduces the term *quadratic set* (ensemble quadratique) as a generalization of a quadric.

Definition 6.2 Let be $\mathfrak{P} = (\mathcal{P}, \mathcal{G}, \in)$ a projective space. A non empty subset \mathcal{M} of \mathcal{P} is called **quadratic set** if

Any line g of \mathcal{G} intersects \mathcal{M} in at most 2 points or is contained in \mathcal{M} .

(QM1) (g is called **exterior, tangent and secant** line if $|g \cap \mathcal{M}| = 0$, $|g \cap \mathcal{M}| = 1$ and $|g \cap \mathcal{M}| = 2$ respectively.)

(QM2) For any point $P \in \mathcal{M}$ the union \mathcal{M}_P of all tangent lines through P is a hyperplane or the entire space \mathcal{P} .

A quadratic set \mathcal{M} is called **non degenerated** if for any point P set \mathcal{M}_P is a hyperplane.

The following statement is essential for Minkowski–planes (s. Section 5.3.7).

Result 6.11 (BUEKENHOUT [BU'69], Theorem 3) Let be \mathfrak{P}_n a finite projective space of dimension $n \geq 3$ and \mathcal{M} a non degenerated quadratic set which contains lines. Then: \mathfrak{P}_n is pappian and \mathcal{M} is a quadric with index ≥ 2 .

Definition 6.3 Let \mathfrak{P} be a projective space of dimension ≥ 2 . A non degenerated quadratic set \mathcal{O} that does not contain lines is called **ovoid** (or **oval** in plane case).

Example 6.3

a) Any sphere (quadric of index 1) is an ovoid.

b) In case of real projective spaces one can construct ovoids by combining halves of suitable ellipsoids such that they are no quadrics.

Another method is described in [HA'84]:

Let be $\mathfrak{A}_n(\mathbb{R})$ the real affine space of dimension $n \geq 2$ (with point set \mathbb{R}^n, \dots) and

$f_i(x) = x^2$ or x^4 or $\cosh x$ (s. [HA'84]). Then

$\mathcal{O} := \{(x_1, \dots, x_n) \in \mathbb{R}^n \mid x_n = \sum_{i=1}^{n-1} f_i(x_i)\} \cup \{X_n^\infty\}$

(X_n^∞ is the point at infinity of the x_n -axis.)

is an ovoid in the projective closure $\overline{\mathfrak{A}_n(\mathbb{R})}$.

c) With help of transfinite induction it can be shown that for any projective space of infinite order there exist ovoids (s. [HE'71], Satz 3.4).

For **finite** projective spaces we have:

Result 6.12 (s. [DE'68], pages 48,49) a) In case of $|K| < \infty$ an ovoid in $\mathfrak{P}_n(K)$ exists only if $n = 2$ or $n = 3$.

b) In case of $|K| < \infty$, $\text{char} K \neq 2$ an ovoid in $\mathfrak{P}_n(K)$ is a quadric.

The counter examples below show that in general statement b) of the theorem above is not true for $\text{char} K = 2$:

Let be K a finite field of even order.

- a) If the order of K is large enough there exist translation ovals in $\mathfrak{P}_2(K)$ which are no quadrics (s. [DE'68], p. 51).
- b) Let be $K = GF(2^n)$, n odd and σ the automorphism $x \rightarrow x^{(2^{\frac{n+1}{2}})}$.
 For the affine space $\mathfrak{A}_3(K)$ with point set K^3 we define
 $\mathcal{O}' := \{(x, y, z) \in K^3 \mid z = xy + x^2x^\sigma + y^\sigma\}$.
 In $\mathfrak{P}_3(K)$ (projective closure of $\mathfrak{A}_3(K)$) we extend \mathcal{O}' to
 $\mathcal{O} := \mathcal{O}' \cup \{\text{point at infinity of the z-axis}\}$.
 Then \mathcal{O} is an ovoid of $\mathfrak{P}_3(K)$ (s. [DE'68], p. 52).
 \mathcal{O} is called **TITS-SUZUKI-ovoid**. In case $n = 1$, only, set \mathcal{O} is a quadric.

6.4 Final remarks

It is not reasonable to define formally quadrics for vector spaces over genuine *skewfields*. Because one would get secants bearing more than 2 points of the quadric which is totally different to “usual” quadrics. The reason is the following statement.

Theorem 6.13 *A skewfield is commutative if and only if any equation $x^2 + ax + b = 0$, $a, b \in K$ has at most two solutions.*

Proof: I) If K is commutative and $x_0 \neq x_1$ solutions of equation $x^2 + ax + b = 0$, we conclude: $a = -(x_0 + x_1)$ and $b = x_0x_1$. Hence $x^2 + ax + b = 0$ is equivalent to $(x - x_0)(x - x_1) = 0$ which obviously has only the solutions x_0, x_1 .

II) Let any equation $x^2 + ax + b = 0$ have only two solutions. For arbitrary x_0, c equation (1): $(x - x_0)(x - x_0) + (x - x_0)x_0 - c(x - x_0) = 0$ is an equation of form $x^2 + ax + b = 0$ and x_0 is a solution. For $x \neq x_0$ equation (1) is equivalent to

$$(2): x_0(x - x_0)^{-1} - (x - x_0)^{-1}c = -1.$$

Using the abbreviation $z := (x - x_0)^{-1}$ one gets the *linear* equation

$$(3): x_0z - zc = -1.$$

If (1) has exactly one further solution $x \neq x_0$ the linear equation (3) has exactly *one* solution and the corresponding *homogeneous* equation

$$(4): x_0z - zc = 0$$

only the trivial solution.

Let us *assume* there exist *conjugated* elements $x_0 \neq x_1$ (in K).

For $c = (x_1 - x_0)x_1(x_1 - x_0)^{-1}$ equation (1) would have the sole additional solution x_1 and (4) would have only solution $z = 0$. Conclusion: x_0 and c would *not* be conjugated and hence x_0 and x_1 would *not* be conjugated, either. This is a contradiction and all classes of conjugated elements consist of *one* element, i.e. K is commutative. \square

Geometrical consequence: The “curves” $y = x^2$ and $y = x^{-1}$ in K^2 over a *genuine* skewfield is not a parabolic or hyperbolic curve (s. [AR'71], [BZ'62], [KÜ'71]).

I

Chapter 7

Appendix: Nearfields

Literature: [WÄ'87]

A *nearfield* can be considered as a generalization of the term skewfield. One just abandons one of the two distributive laws. Genuine Nearfields are used to construct

- a) non desarguesian affine and projective planes.
- b) sharply 3-transitive permutation groups which are no PGLs over a field.
- c) non miquelian Minkowski-planes.

7.1 Definition of a nearfield and some rules

A set K along with two operations $+$ and \cdot is called **nearfield** if

- (F1) $(K, +)$ is a group (0 its neutral element).
- (F2) $(K \setminus \{0\}, \cdot)$ is a group (1 its neutral element).
- (F3) $a(b + c) = ab + ac$ for any $a, b, c \in K$.
- (F4) $a = 0$ for any $a \in K$.

Result 7.1 ((s. [WÄ'87])) *For an arbitrary nearfield the following is true*

- a) $a0 = 0$ for any $a \in K$.
- b) $x(-y) = -(xy)$ for any $x, y \in K$.
- c) $(-1)^2 = 1$.
- d) Equation $x^2 = 1$ has only the solutions 1 and -1 .
- e) $(K, +)$ is commutative.

7.2 Examples of nearfields

Result 7.2 (ZASSENHAUS [ZA'36b]) *All the finite nearfields are known. Until 7 exceptions they are constructed by suitable manipulations of the multiplication of finite fields (s. [DE'68], p. 230).*

Examples of infinite nearfields can be found in [KE'74].

For Minkowski–planes TITS–nearfields are essential, only. Thus, in Section 7.5 we give examples of TITS–nearfields.

7.3 Planar nearfields

A nearfield is called **planar** if

(p) *For any $a, b \in K$ with $a \neq 1$ equation $ax - x = b$ has a solution in K .*

Property (p) is essential for the following statement.

Theorem 7.3 *Let be $(K, +, \cdot)$ a planar nearfield and*

$\mathcal{P} = K^2$ *and the set of points*

$\mathcal{G} = \{ \{(x, y) \in \mathcal{P} \mid y = mx + b\} \mid m, b \in K \} \cup \{ \{(x, y) \in \mathcal{P} \mid x = c\} \mid c \in K \}$ *the set of lines.*

The incidence structure $\mathfrak{A}(K) = (\mathcal{P}, \mathcal{G}, \in)$ is an affine plane.

There exist examples of *non planar* nearfields (s. [KE'74]). For finite nearfields we have

Theorem 7.4 *Any finite nearfield is planar.*

Proof: In the finite case from the injectivity of mapping $x \rightarrow ax - x$ for $a \neq 1$ we get its surjectivity and hence for any $a, b \in K$ with $a \neq 1$ equation $ax - x = b$ has a solution in K . \square

7.4 Nearfields and sharply 2–transitive permutation-groups

Alike the case of a field one proves

Theorem 7.5 *For any nearfield $(K, +, \cdot)$ the set $\Pi := \{x \rightarrow ax + b \mid a, b \in K, a \neq 0\}$ of permutations is a group and operates on K sharply 2–transitive (i.e. for any 4 elements $x_1, x_2, y_1, y_2 \in K$ there is exactly one $\pi \in \Pi$ such that $\pi(x_1)y_1$ and $\pi(x_2)y_2$).*

All examples of sharply 2–transitive operating permutation groups known till now (1985) can be represented over nearfields described above.

7.5 TITS-nearfields and sharply 3-transitive permutationgroups

A nearfield is called **TITS-nearfield** if

- (t) *There exists an involutory automorphism f of $(K \setminus \{0\}, \cdot)$ with*
 $f(f(x) + 1) = 1 - f(x + 1)$ *for any $x \in K \setminus \{0, -1\}$.*

The importance of TITS-nearfields is due to

Result 7.6 (s. [KE'74], 11) *Let be $(K, +, \cdot, f)$ a TITS-nearfield, $\infty \notin K$ and $\infty \cdot a = \infty$, $\infty + a = \infty$ for any $a \in K$ and $\bar{f} : K \cup \{\infty\} \rightarrow K \cup \{\infty\}$ with $\bar{f}(0) = \infty$, $\bar{f}(\infty) = 0$, $\bar{f}(x) = f(x)$ for $x \in K \setminus \{0\}$. Then $\Pi(K, f) := \{x \rightarrow ax + b \mid a, b \in K, a \neq 0\} \cup \{x \rightarrow a\bar{f}(x - b) + c \mid a, b, c \in K, a \neq 0\}$ is a sharply 3-transitive permutationgroup operating on $K \cup \{\infty\}$.*

Example 7.1 a) $(K, +, \cdot)$ is a field and $f(x) = \frac{1}{x}$.

- b) *Let be $(K, +, \cdot)$ a field with an involutorial automorphism σ and a subgroup A of $(K \setminus \{0\}, \cdot)$ of index 2.*

Then $(K, +, \circ, f)$ with

$$a \circ b := \begin{cases} ab & \text{if } a \in A \\ a\sigma(b) & \text{if } a \notin A \end{cases} \quad \text{and } f : \text{inverse mapping of group } (K \setminus \{0\}, \cdot)$$

is a genuine TITS-nearfield (s. [WÄ'87], Satz 2.2).

- 1) *For $K = GF(p^2)$, $p \neq 2$, (field with p^2 elements),
 $A =$ set of squares in $GF(p^2)$ and $\sigma : x \rightarrow x^\sigma$
we get a TITS-nearfield, we denote it by $TNF(p^2)$.*

- 2) *Infinite (genuine) TITS-nearfields can be found in [KE'74], p. 65.*

Result 7.7 (ZASSENHAUS [ZA'36a]) *For a finite TITS-nearfield $(K, +, \cdot, f)$ the following is true:*

K is a field or K is a TITS-nearfield $TNF(p^2)$ (s. above).

Result 7.8 (BENZ, ELLIGER [BE,EL'68], HARTMANN [HA'79b]) *For a finite TITS-nearfield $(K, +, \cdot, f)$ the following is true:*

If $(K, +, \cdot)$ is a skewfield then $(K, +, \cdot)$ is a field and $f(x) = \frac{1}{x}$.

Result 7.9 (WEFELSCHIED, s. [WÄ'87]) *All TITS-nearfields known till now (1985) are planar.*

In Section 5.5.4 we use the following characterization of the groups $PGL(2, K)$.

Result 7.10 (TITS, s. [MÄ'83]) *A sharply 3-transitive operating permutationgroup is isomorphic to a group $PGL(2, K)$ if and only if (I) A permutation that exchanges two points is an i*

Bibliography

- [AR'68] Artzy, R.: *Pascal's theorem on an oval*.
Americ. Math. Monthly 75 (1968), 143–146
- [AR'71] Artzy, R.: *The conic $y = x^2$ in Moufang planes*.
Aequationes Math. 6 (1971), 31–35
- [AR'73a] Artzy, R.: *A Pascal theorem applied to Minkowski geometry*.
J. Geometry 3 (1973), 93–102
- [AR'73b] Artzy, R.: *Appendum to a "A Pascal theorem applied to Minkowski geometry"*.
J. Geometry 3 (1973), 103–105
- [AR'77] Artzy, R.: *Minkowski parallel-translation planes and their coordinatization*.
J. Geometry 5 (1977), 19–27
- [BE,EL'68] Benz, W. / Elliger, S.: *Über die Funktionalgleichung $f(1+x)+f(1+f(x)) = 1$* .
Aequationes Math. 1 (1968), 267–274
- [BE'69] Benz, W.: *Zur Geometrie der Körpererweiterungen*.
Canad. J. Math. 21 (1969), 1097–1122
- [BE'70a] Benz, W.: *Ein gruppentheoretisches Modell der Pseudoeuklidischen (Minkowskischen) Geometrie*.
Mathematica 12 (35), 1, (1970), 21–23
- [BE'70b] Benz, W.: *Permutations and plane sections of a ruled quadric*.
Symposia Mathematica, Instit. Naz. d. Alta Mathem. 5 (1970), 325–339
- [BE'73] Benz, W.: *Vorlesungen über Geometrie der Algebren*.
Die Grundlehren der mathematischen Wissenschaften in Einzeldarstellungen Bd. 197, Springer Berlin/Heidelberg/New York 1973, 363 S.
- [BZ'62] Berz, E.: *Kegelschnitte in Desarguesschen Ebenen*.
Math. Zeitschr. 78 (1962), 55–85

- [BT'81] Betten, D.: *Der Satz von Miquel als räumlicher Dreispiegelungssatz.*
Der Mathematische und Naturwissenschaftliche Unterricht 34. Jahrg., Heft 7 (1981), 385–387
- [BP'83] Beutelspacher, A.: *Einführung in die endliche Geometrie II.*
Bibliographisches Institut Mannheim/Wien/Zürich (1983)
- [BR'76] Brauner, H.: *Geometrie projektiver Räume I.*
Bibliographisches Institut Mannheim/Wien/Zürich (1976), 225 S.
- [BN'79] Buchanan, Th.: *Ovale und Kegelschnitte in der komplexen projektiven Ebene.*
Math.-phys. Semesterber. 26 (1979), 243–260
- [BN,HÄ,LÖ'80] Buchanan, Th. / Hähl, H. / Löwen, R.: *Topologische Ovale.*
Geom. Dedicata 9 (1980), 401–424
- [BU'66] Buekenhout, F.: *Plans Projectifs à Ovoides Pascaliens.*
Arch. Math. 17 (1966), 89–93
- [BU'69] Buekenhout, F.: *Ensembles Quadratiques des Espaces Projectifs.*
Math. Z. 110 (1969), 306–318
- [BU'76] Buekenhout, F.: *Characterizations of semi quadrics.*
Atti dei Convegni Lincei 17 (1976), 393–421
- [CH'70] Chen, Yi: *Der Satz von Miquel in der Möbius-Ebene.*
Math. Ann. 186 (1970), 81–100
- [CH,KA'73] Chen, Yi / Kaerlein, G.: *Eine Bemerkung über endliche Laguerre- und Minkowski-Ebenen.*
Geom. Dedicata 2 (1973), 193–194
- [CH'74] Chen, Yi: *A characterization of some geometries of chains.*
Can. J. Math. 26 (1974), 257–272
- [CO'77] Cohn, P.M.: *Algebra.*
John Wiley & Sons 2 London/New York/Sidney/Toronto 1977, 482 S.
- [DE,PR'76] Degen, W. / Profke, L.: *Grundlagen der affinen und euklidischen Geometrie.*
Teubner-Verlag Stuttgart 1976
- [DE'64] Dembowski, P.: *Möbiusebenen gerader Ordnung.*
Math. Annalen 157 (1964); 179–205

- [DE'68] Dembowski, P.: *Finite geometries*.
Ergebnisse der Mathematik und ihrer Grenzgebiete Bd. 44, Springer Verlag
Berlin/Heidelberg/New York 1968
- [DI'77] Dienst, K.J.: *Minkowski-Ebenen mit Spiegelungen*.
Monatsh. Math. 84 (1977), 197–208
- [DD'71] Dieudonné, J.: *La géométrie des groupes classiques*.
Ergebnisse der Mathematik und ihrer Grenzgebiete Bd. 5, Springer
Berlin/Heidelberg/New York 1971, 129 S.
- [EW'67] Ewald, G.: *Aus konvexen Kurven bestehende Möbius-Ebenen*.
Abh. math. Sem. 30 (1967), 179–187
- [EW'71] *Geometry: An Introduction*.
Belmont, Calif.: Wadsworth Publishing Company, Inc. (1971)
- [FU'82] Funk, M.: *Der Satz von v. Staudt-Schleiermacher in Minkowski-Ebenen*.
Monatsh. Math. Bd. 93 (1982), 1–14
- [GR'71] Groh, H.: *On flat Laguerre planes*.
J. Geometry 1 (1971), 18–40
- [GR'72] Groh, H.: *Flat Moebius planes*.
Geom. Dedicata 1 (1972), 65–84
- [GR'74a] Groh, H.: *Flat Moebius and Laguerre planes*.
Abh. Math. Semin. Univ. Hamburg Bd. 40 (1974), 64–76
- [GR'74b] Groh, H.: *Laguerre planes generated by Moebius planes*.
Abh. Math. Semin. Univ. Hamburg Bd. 40 (1974), 43–63
- [GR'74c] Groh, H.: *Ovals and non-ovoidal Laguerre planes*.
J. Reine Angew. Math. Bd. 267 (1974), 50–66
- [HA'76] Hartmann, E.: *Moulton-Laguerre-Ebenen*.
Arch. Math. 27 (1976), 424–435
- [HA'78] Hartmann, E.: *Möbiusebenen über pythagoreischen Körpern*.
Geom. Dedicata 7 (1978), 303–310
- [HA'79a] Hartmann, E.: *Eine Klasse nicht einbettbarer reeller Laguerre-Ebenen*.
J. Geometry 13 (1979), 49–67
- [HA'79b] Hartmann, E.: *Über zwei Klassen von Tits-Fastkörpern*.
Mitt. math. Ges. Hamb. 10 (1980) 757–762

- [HA'81a] Hartmann, E.: *Beispiele nicht einbettbarer reeller Minkowski-Ebenen.*
Geom. Dedicata 10 (1981), 155–159
- [HA'81b] Hartmann, E.: *Zykel- und Erzeugendenspiegelungen in Minkowski-Ebenen.*
Geom. Dedicata 11 (1981), 489–503
- [HA'81c] Hartmann, E.: *Über Moufang-Ovale.*
Aeq. Mathem. 23 (1981), 188–196
- [HA'82a] Hartmann, E.: *Minkowski-Ebenen mit Transitivitätseigenschaften.*
Result. Mathem. 5 (1982), 136–148
- [HA'82b] Hartmann, E.: *Transitivitätssätze für Laguerre-Ebenen.*
J. Geometry 18 (1982), 9–27
- [HA'84] Hartmann, E.: *Ovoide und Möbius-Ebenen über konvexen Funktionen.*
Geom. Dedicata 15 (1984), 377–388
- [HE'71] Heise, W.: *Bericht über κ -affine Geometrien.*
J. Geometry 1 (1971), 197–224
- [HE,KA'73a] Heise, W. / Karzel, H.: *Symmetrische Minkowski-Ebenen.*
J. Geometry 3 (1973), 5–20
- [HE,KA'73b] Heise, W. / Karzel, H.: *Vollkommen Fanosche Minkowski-Ebenen.*
J. Geometry 3 (1973), 21–29
- [HE'74] Heise, W.: *Minkowski-Ebenen gerader Ordnung.*
J. Geometry 5 (1974), 83
- [HE,SE'75] Heise, W. / Seybold, H.: *Das Existenzproblem der Möbius-, Laguerre- und Minkowski-Erweiterungen endlicher affiner Ebenen.*
Bayerische Akademie der Wissenschaften, Sitzungsberichte (1975), 43–58
- [HU,PI'73] Hughes, D.R. / Piper, F.C.: *Projective planes.*
Springer Verlag New York, Heidelberg, Berlin 1973
- [HZ'79] Herzer, A.: *Über Kreisebenen mit Potenzlinie.*
Arch. Math. 33 (1979), 294–304
- [HO'71] Hofmann, C.E.: *Specializations of Pascal's Theorem on an Oval.*
J. Geometry 1 (1971) 143–153
- [KH'80] Kahn, J.: *Locally projective-planar lattices which satisfy the bundle theorem.*
Math. Z. 175 (1980), 219–247

- [KA'73] Karzel, H., Sörensen K., Windelberg, D.: *Einführung in die Geometrie*. Göttingen: Vandenhoeck & Ruprecht. 217 (1973)
- [KA,SÖ'77] Karzel, H. / Sörensen, K.: *Projektive Ebenen mit einem Pascalschen Oval*. Abh. Math. Sem. Hamburg 36 (1977), 123–125
- [KA'78] Karzel, H.: *Symmetrische Permutationsmengen*. Aequationes Math. 17 (1978), 83–90
- [KA,MÄ'82] Karzel, H. / Mäurer, H.: *Eine Kennzeichnung Miquelscher Möbiusebenen durch eine Eigenschaft der Kreisspiegelungen*. Result. Mathem. 5 (1982), 52–56
- [KE'74] Kerby, W.: *On infinite sharply multiply transitive groups*. Hamburger Mathematische Einzelschriften Neue Folge/ Heft 6, v.d. Hoeck + Ruprecht Göttingen 1974
- [KL'79] Kleinewillinghöfer, R.: *Eine Klassifikation der Laguerre-Ebenen*. Dissertation TH Darmstadt (1979), 1–68
- [KL'80] Kleinewillinghöfer, R.: *Eine Klassifikation der Laguerre-Ebenen nach L-Streckungen und L-Translationen*. Arch. Math. 34 (1980), 469–480
- [KB'76] Krebs, R.: *Involutorische Automorphismen von Laguerre-Ebenen*. Dissertation TH Darmstadt (1976), 1–89
- [KR'79] Krier, N.: *Some Constructions of infinite Möbius-Planes*. TAMS 254 (1979), 95–115
- [KÜ'71] Krüger, W.: *Kegelschnitte in Moufangebene*. Math. Z. 120 (1971), 41–60
- [LA'81] Lang, K.: *Kennzeichnung von Möbius-Ebenen durch Spiegelungsrelationen*. J. Geometry 16 (1981), 5–18
- [LA'83] Lang, K.: *Ein einfacher spiegelungsgeometrischer Beweis für den Schließungssatz von Miquel*. Math. Semesterber. Bd. 30 (1983), 18–25
- [LE'65] Lenz, H.: *Vorlesungen über projektive Geometrie*. Akademische Verlagsgesellschaft Leipzig 1965, 354 S.
- [LI'78] Lingenberg, R.: *Grundlagen der Geometrie*. Bibliographisches Institut Mannheim/Wien/Zürich 1978, 218 S.

- [MÄ'67] Mäurer, H.: *Möbius- und Laguerre-Geometrien über schwach konvexen Semiflächen.*
Math. Zeitschr. 98 (1967), 355–386
- [MÄ'70] Mäurer, H.: *Spiegelungen an Halbovoiden.*
Arch. Math. 21 (1970), 411–415
- [MÄ'72] Mäurer, H.: *Eine Kennzeichnung halbovoidaler Laguerre-Geometrien.*
J. Reine Angew. Math. 253 (1972), 203–213
- [MÄ'73] Mäurer, H.: *Zu Punktepaaren symmetrische Ovoide.*
Arch. Math. 24 (1973), 434–439
- [MÄ'76a] Mäurer, H.: *Laguerre-Ebenen mit Symmetrien an Punktepaaren und Zykeln.*
J. Geometry 8 (1976), 79–93
- [MÄ'76b] Mäurer, H.: *Ovoide mit Symmetrien an den Punkten einer Hyperebene.*
Abh. Math. Sem. Hamburg 45 (1976), 237–244
- [MÄ'77] Mäurer, H.: *Die Bedeutung des Spiegelungsbegriffs in der Möbius- und der Laguerre-Geometrie.*
Beiträge zur Geometrischen Algebra (1977), 251–258
- [MÄ'78] Mäurer, H.: *Involutorische Automorphismen von Laguerre-Ebenen mit genau zwei Fixpunkten.*
Monatsh. Math. 86 (1978), 131–142
- [MÄ,ME,NO'80] Mäurer, H. / Metz, R. / Nolte, W.: *Die Automorphismengruppe der Möbius-Geometrie einer Körpererweiterung.*
Aequationes Math. 21 (1980), 110–112
- [MÄ'81] Mäurer, H.: *Symmetries of Quadrics.*
Geometry – von Staudt's Point of View, Proc. of the NATO Advanced Study held at Bad Windsheim 1980, Reidel Publ. Co Dordrecht, Holland 1981
- [MÄ'83] Mäurer, H.: *Permutationsgruppen ohne Pseudoinvolutionen, in deren Standgruppen die Involutionen regulär operieren.*
J. Algebra 82 (1983), 539–545
- [PA'71] Payne, E.: *A complete determination of translation ovoids in finite desarguian planes.*
Accademia Nazionale dei Lincei Serie VIII, Vol. LI, Fasc. 5 (1971), 226–229

- [PE'74] Percsy, N.: *A characterization of classical Minkowski planes over a perfect field of characteristics two.*
J. Geometry 5 (1974), 191–204
- [PE'79] Percsy, N.: *A Remark on the introduction of coordinates in Minkowski planes.*
J. Geometry 12 (1979), 175–183
- [PE'81] Percsy, N.: *Finite Minkowski planes in which every circle-symmetry is an automorphism.*
Geom. Dedicata 10 (1981), 269–282
- [PE'83] Percsy, N.: *Les plans de Minkowski possédant des inversions sont Miquelliens.*
Simon Stevin 57 (1983), 15–35
- [PI'55] Pickert, G.: *Projektive Ebenen.*
Grundl. d. math. Wiss. i. Einzeld. 80, Springer Verlag
Berlin/Göttingen/Heidelberg
- [QV'52] Qvist, B.: *Some remarks concerning curves of the second degree in a finite plane.*
Ann. Acad. Sci. Fenn. 134 (1952), 1–27
- [RO,VA'73] Roberts, A.W. / Varberg, D.E.: *Convex functions.*
Academic Press 57 New York/London 1973, 287 S.
- [SC'80] Schenkel, A.: *Topologische Minkowskiebene.*
Dissertation, Univ. Erlangen-Nürnberg 1980
- [SR'82] Schröder, E.: *Ein neuer Winkelbegriff für die Elementargeometrie.*
Prax. Math. Heft 9 (1982), 257–267
- [SE'55] Segre, B.: *Ovals in a finite projective plane.*
Canad. Journal of Math. 7 (1955), 414–416
- [SE'57] Segre, B.: *Sui k -archi nei piani finite di caratteristica due.*
Rev. Math. Pures Appl. 2 (1957), 289–300
- [TH'74] Thas, J.A.: *On semi ovals and semi ovoids.*
Geom. Dedicata 3 (1974), 229–231
- [TI'62] Tits, J.: *Ovoides à translations.*
Rend. Mat. 21 (1962), 37–59
- [WA,SM'35] Waerden, v.d. B.L. / Smid, L.J.: *Eine Axiomatik der Kreisgeometrie und der Laguerregeometrie.*
Math. Ann. 110 (1935), 753–776

- [WÄ'87] Wähling, H.: *Theorie der Fastkörper*.
Thales-Verl. (1987)
- [WE'76] Wefelscheid, H.: *Zur Charakterisierung einer Klasse von Hyperbelstrukturen*.
J. Geometry 9 (1976), 127–133
- [WE'77] Wefelscheid, H.: *Über die Automorphismengruppen von Hyperbelstrukturen*.
Beiträge zur Geometrischen Algebra (1977), 337–343
- [WE'78] Wefelscheid, H.: *Verallgemeinerte Minkowski-Geometrie*.
Contrib. to Geometry Siegen (1978), 397–406
- [WE'79] Wefelscheid, H.: *Eine Orthogonalitätsbeziehung in Hyperbelstrukturen*.
Abh. Math. Semin. Univ. Hamb. 48 (1979), 225–230
- [WE'81] Wefelscheid, H.: *Zur Planarität von KT -Fastkörpern*.
Arch. Math. 36 (1981), 302–304
- [WI'82a] Wilbrink, H.A.: *Finite Minkowski Planes*.
Geom. Dedicata 12 (1982), 119–129
- [WI'82b] Wilbrink, H.A.: *Two-transitive Minkowski Planes*.
Geom. Dedicata 12 (1982), 383–395
- [ZA'36a] Zassenhaus, H.: *Kennzeichnung endlicher linearer Gruppen als Permutationsgruppen*.
Abh. Math. Sem. Hamburg 11 (1936), 17–40
- [ZA'36b] Zassenhaus, H.: *Über endliche Fastkörper*.
Abh. Math. Sem. Hamburg 11 (1936), 187–220
- [ZE'77] Zeitler, H.: *Über (K, L) -Ebenen*.
Dissertation, Gesamthochschule Kassel 1977